



## RC8X

( FHSS, 8-Channel Digital Proportional RC System )

Adaptable to RC Cars/Boats/Robots

## Instruction Manual



## Contents

I. RC8X Remote Control System .....	4
1.1 Safety Precautions .....	4
1.1.1 Safety Guidelines for Transmitter .....	4
1.1.2 Safety Guidelines for SD Card .....	4
1.2 RC8X Introduction .....	5
1.2.1 Features .....	5
1.2.2 Specifications .....	5
1.2.3 Package List .....	7
1.2.4 Compatible Receivers .....	7
1.2.5 Buttons Introduction .....	8
1.2.6 Nomenclature of Buttons .....	9
1.2.7 Two Position Switch .....	10
1.2.8 Three Position Switch .....	11
1.2.9 Preparation before Turn on Transmitter .....	12
1.2.10 Icon Introduction .....	15
1.2.11 Transmitter Low Voltage Alarm .....	15
1.3 Receiver Introduction .....	16
1.3.1 Features of R8FG .....	16
1.3.2 Binding .....	16
1.3.3 Receiver Connection .....	16
1.3.4 Working Mode of R8FG .....	19
1.3.5 Gyro Function of R8FG .....	20
1.3.6 Installment of Receiver Antenna .....	21
1.3.7 RSSI Testing .....	21
II. RC8X Basic Functions .....	22
2.1 System menu setting .....	22
2.1.1 Desktop setting .....	22
2.1.2 System theme setting .....	22
2.1.3 Backlight .....	23
2.1.4 Sound .....	24
2.1.5 Battery (Transmitter Battery Voltage) .....	25
2.1.6 Vibration setting .....	26
2.1.7 LED setting .....	26
2.1.8 HOME button setting .....	26
2.1.9 External input output .....	27
2.1.10 Calibration .....	28
2.2 Tools menu .....	29
2.2.1 Trim/Dial select .....	29
2.2.2 Switch select .....	31
2.2.3 Screenshot setting .....	34
2.2.4 Timer .....	36

2.2.5 Lap list .....	37
2.2.6 Roll out chart .....	37
2.2.7 Gear ratio chart .....	37
2.3 Basic menu .....	38
2.3.1 Receiver select .....	38
2.3.2 Child ID mode .....	38
2.3.3 Servo view .....	39
2.3.4 Throttle Setting (Trigger) .....	39
2.3.4.1 Cruise Control .....	40
2.3.5 Channel reverse .....	41
2.3.6 Sub trim .....	41
2.3.7 End point (EPA) .....	41
2.3.8 Fail-safe .....	42
2.3.9 Acceleration .....	42
2.3.10 Condition .....	42
2.3.11 Idle up .....	43
2.3.12 D/R, ATL .....	43
2.3.13 Channel limiter .....	44
2.3.14 Channel setting .....	44
2.4 Telemetry menu .....	45
2.4.1 Sensor list .....	45
2.4.2 Sensor setting .....	45
2.4.3 Voice .....	46
2.5 Racing curve .....	47
2.5.1 Steering curve .....	47
2.5.2 Throttle curve .....	48
2.5.3 Brake curve .....	49
2.5.4 Steering speed .....	49
2.5.5 Throttle speed .....	50
2.5.6 Traction control (T.R.C) .....	52
2.5.7 A.B.S .....	53
2.5.8 Start .....	54
2.5.9 Engine cut .....	55
2.6 Mixing menu .....	56
2.6.1 Steering mixing .....	56
2.6.2 Brake mixing .....	57
2.6.3 Gyro mixing .....	58
2.6.4 4WS mixing .....	59
2.6.5 Dual ESC mixing .....	60
2.6.6 CPS mixing .....	61
2.6.7 Tank mixing .....	63
2.6.8 Programmable mixing .....	63

2.6.9 Tilt mixing.....	65
2.7 Model select.....	66
2.7.1 Model select.....	66
2.7.2 Copy model/Paste model.....	66
2.7.3 Rename model.....	67
2.7.4 Reset model.....	67
2.7.5 Delete model.....	67
2.8 SD Card Folder.....	67
2.8.1 SD Card Folder Name Introduction.....	67
2.8.2 SD Card Files Copy Methods.....	68
2.8.3 Note for SD card content modification.....	70
2.9 Information.....	71
2.9.1 User name.....	71
2.9.2 Language.....	71
2.9.3 Reset system settings.....	71
2.10 Modifying for Left-hand Use.....	71
2.10.1 Remove the Wheel.....	71
2.10.2 Remove the Wheel Installation Port Cover.....	72
2.10.3 Install Wheel.....	73
2.10.4 Install the Wheel Installation Port Cover.....	73
2.11 Wheel or Trigger Mechanical Adjustment.....	74
2.11.1 Trigger brake lever adjustment.....	74
2.11.2 Trigger tension screw adjustment.....	75
2.11.3 Trigger slide adjustment.....	75
2.11.4 Wheel tension screw adjustment.....	76
2.12 Firmware Update.....	76
2.12.1 Methods for Firmware Copy.....	76
2.12.2 Methods for Firmware Upgrade.....	76
2.13 Customized Voice Production.....	80
Thanks.....	82

## I. RC8X Remote Control System

### 1.1 Safety Precautions

#### 1.1.1 Safety Guidelines for Transmitter

- 1) Do not operate outdoors on rainy days, run through puddles of water, or use when visibility is limited. Should any type of moisture (water or snow) enter any component of the system, erratic operation and loss of control may occur.
- 2) Do not operate in the places that near people or roads.
- 3) This product is not a toy and is NOT suitable for children under the age of 14. Adults should keep the product out of the reach of children and exercise caution when operating this product in the presence of children.
- 4) Always ensure the trim levers at 0 and battery properly charged before connecting the receiver.
- 5) Always check the throttle trigger on the transmitter to be sure it is at the neutral position before turning on the power switches of transmitter and receiver. Always be sure the engine is not running or the motor is stopped before turning off the power switches.
- 6) Make sure that turn on the transmitter power switch and then turn on the receiver or speed control power switch when you ready to operate the model. Make sure that turn off the receiver or speed control power switch and then turn off the transmitter power switch when you ready to stop to operate the model. If the power switches are turned on or turned off in the opposite order, the model may unexpectedly run out of control and cause a very dangerous situation.
- 7) Before running, check if the function moves the servos to the preset position. Trigger the throttle trigger and steering the steering wheel to check if the motor and servo move to the preset position. When adjusting the model, make sure the engine not running. You may unexpectedly lose control and create a dangerous situation.
- 8) Never power on the RC8X out of 7.0V-17V. 8 pieces AAA batteries , a 2S-4S LiPo battery or a 6S Ni-MH battery is permitted.
- 9) Never charge the RC8X with the USB port. The Type-C port on the left of RC8X is used to update firmware, copy data, supply power to the 5.8G image transmission module, and temporarily supply power to RC8X. It cannot be used to charge the battery of RC8X.

#### 1.1.2 Safety Guidelines for SD Card

- 1 . Never unplug and plug the Micro SD card when the transmitter turns on, especially the transmitter is reading the data, or it will damage the SD card or loss of data.
- 2 . A SD card needs to be inserted into the RC8X for normal use. Please make sure the SD card is inserted before use.

## 1.2 RC8X Introduction

### 1.2.1 Features

RC8X, an 8 channels transmitter, with a 4.3 inches, full-color, backlight LCD touch screen, which runs smoothly like a smart phone.

It is packed with the R8FG receiver, with built-in gyro and supports high voltage servo, which is capable of RSSI (Received Signal Strength Indicator), receiver and model battery voltage telemetry.

RC8X is capable of an arbitrary ID designation among a maximum of 16 binding receivers and can keep a maximum of 200 pieces model parameters saved.

Setting Menu, font, desktop, system theme, etc., can be customized, you can achieve a totally unique 8 channels transmitter without one code to modify.

Multiple Programmable Mix Control such as 4WS, 4WD, Tank mixing, Tilt mixing, CPS mixing etc.

RC8X, with steering curve, throttle curve, brake curve, etc., that is an ideal partner for all types RC cars and boats in the market including single-engine and twin-engine models such as crawlers, tanks, caterpillars, short-course truck, drifting car, gasoline car, mini car, monster truck, off-road car, GP car, EP car and other types of cars or boats.

### 1.2.2 Specifications

<b>RC8X Transmitter</b>	
Dimensions	L*W*H: 121*163*109mm(4.76" *6.42" *4.29" )
Weight	438.5g(15.47oz)
Model Types	Car (Including Crawlers/Tanks/Caterpillars etc.)/Boat/Robot
Channels	8 channels
Screen	4.3 inches, full-color, backlight LCD touch screen
Control Distance	Ground 600 meters(1968.5ft) (Maximum range tested in unobstructed areas free of interference)
Operating Current	250mA ± 10mA@8.4V(the LCD screen light on); 190mA ± 10mA@8.4V(the LCD screen light off)
Operating Voltage	7 ~ 17V DC (8 pieces of AAA batteries or a 2S-4S LiPo battery or a 6S Ni-MH battery)
Antenna	Built-in Antenna
Frequencies Band	2.4GHz ISM ISM band (2400MHz-2483.5MHz)
Modulation Mode	GFSK
Transmission Power	<20dbm
Spread Spectrum	FHSS, 67 channels pseudo random frequency hopping

Channel Resolution	4096 with regular jitter of 0.5us
Low Voltage Alarm	The voltage alarm of transmitter, receiver, and model battery can be customized
Dimension of Battery Case	L*W*H =92*52*14.5mm(3.62" *2.05" *0.57" )
Model Memory	200 models
Compatible Receiver	R8FG(Standard), R7FG, R6FG, R6F, R8EF, R8F, R8FM, R8SM, R8XM, R4F, R4FGM
Voice Broadcast	Yes

### R8FG Receiver

Dimensions	L*W*H =35*24*13.5mm (1.38" *0.94" *0.53" )
Weight	10.5g(0.37oz)
Channel	8 channels
Control Distance	Ground 600 meters (1968.5ft) (Maximum range tested in unobstructed areas free of interference)
Operating Current	30mA
Operating Voltage	3-12V
Signal Output	SBUS&PPM&PWM
Telemetry	Real-time built-in telemetry of model battery voltage, RSSI, and receiver voltage
Water Splash Proof	The waterproof grade is IPX4
Gyro	Receiver with gyro integrated, customizable gyro sensitivity
Compatible Transmitter	RC8X, RC6GS V3, RC6GS V2, RC6GS, RC4GS V3, RC4GS V2, RC4GS, T8FB, T8S

## 1.2.3 Package List



RC8X Transmitter×1



R8FG receiver×1



32G SD Card×1



Lanyard×1



EXT Connect Cable×1



Type-C Cable(for Upgrade)



Manual×1



Packing Box×1

## 1.2.4 Compatible Receivers

RC8X is packed with a R8FG receiver by default. RC8X is also compatible with RadioLink R7FG, R6FG, R6F, R8EF, R8F, R8FM, R8SM, R8XM, R4F, R4FGM receivers.

Note: Since RadioLink radio control system is not open sourced, RadioLink transmitters are ONLY compatible with RadioLink receivers and RadioLink receivers are ONLY compatible with RadioLink transmitters.

Here below are some of the compatible receivers.



R7FG Receiver with Gyro Built-in



R6FG Receiver with Gyro Built-in



R6F Receiver



R8F Receiver 2-way Transmission



R4FGM mini-Receiver



R4F mini-Receiver



## 1.2.5 Buttons Introduction



The USB Type-C port of RC8X is not only used to update firmware, copy data, and supply power to the 5.8G image transmission module, but also used to temporarily supply power to RC8X. When the battery of RC8X is dead or the simulator is used, you can connect the power supply device such as a mobile power bank or a computer to the USB Type-C port to supply 5V power to RC8X, and then long press home button to power on RC8X.

Note:

1. When the USB Type-C port is used to supply power to RC8X, please make sure the battery in the battery tray is removed to avoid over-discharging.
2. The maximum input voltage of the RC8X Type-C port is 5.5V.



## 1.2.6 Nomenclature of Buttons

Switch/Knob	Full name	Function	Operation
DT1	Digital Trim 1	default steering trim	Push the button forward or backward to adjust the value. Restore to factory settings by pushing the buttons. Four DT buttons can work as four 3 position switches by setting. For details of setting, please refer to chapter <a href="#">1.2.8 Three Position Switch</a> .
DT2	Digital Trim 2	default throttle trim	
DT3	Digital Trim 3	Default dual rate	
DT4	Digital Trim 4	Default brake1 rate (ATL*)	
DL1/PS3	Digital Dial 1	Code switch, Gyro gain	Turn the dial clockwise and counterclockwise to adjust the value
	Push Switch 3	Default press PS3 to turn on or turn off backlight, can be programmed	Press switch to enable it

PS1	Push Switch 1	Default control CH4, can be programmed	lock switch or jog switch can be programmed.
PS2	Push Switch 2	Default control CH6, can be programmed	Two PS2 switches on the left and right side, convenient for left and right-handed users
PS4	Push Switch 4	Default control CH7, can be programmed	
PS5	Push Switch 5	Default control CH5, can be programmed	Two PS5 switches on the left and right side, convenient for left and right-handed users
VR	Knob switch	Dial, default control CH3, can be programmed	
HOME		Power switch /Switch for quick back to homepage	
SS	Steering switch	Steering switch controls channel 1 by default to turn the vehicle left and right. You can also assign it to control channel 1 and other functions at the same time.	
TS	Trigger switch	Trigger switch controls channel 2 by default to make the vehicle move forward or backward. You can also assign it to control channel 2 and other functions at the same time.	
ATL	Adjust Throttle Low	Default brake rate	

### 1.2.7 Two Position Switch

PS1, PS2, PS3, PS4, PS5, Steering switch, and Trigger switch can be used as 2 position switches by setting. The setting method is as follows:

(1) Select any one of PS1/PS2/PS3/PS4/PS5/Steering switch/Trigger switch for the channel to be set in the "Channel Setting" menu(The switches of channel 4 to channel 7 are PS1/ PS2/PS4 /PS5 by default, see picture below);

(2) Enter "Switch select" menu, and set the "Type" of the corresponding switch to "lock" , so that when you press the switch once, the channel output will jump from the initial value to maximum value (or minimum value); press the switch again, the channel output will jump to the minimum value (or maximum value).

(3) After setting, the switch can be used as a 2 position switch. Return to the home page and press the corresponding switch to check the servo display.

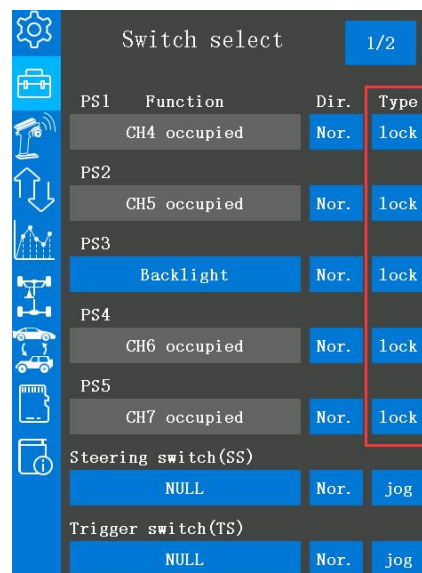
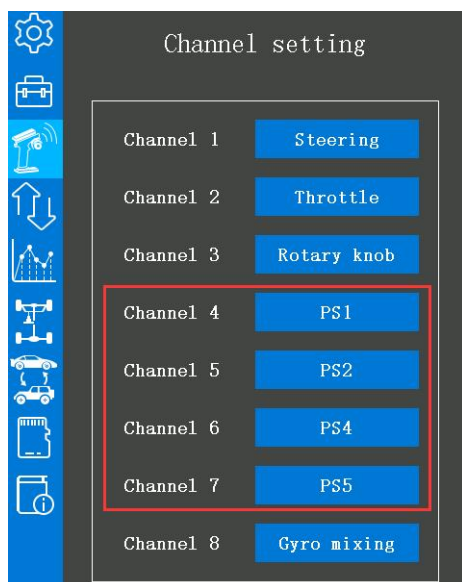

Note: If you set the "Type" of the switch to "jog", the value will reach the maximum (or the minimum) when pressing the switch, and back to the original value when loosen. For example: if the "Type" of PS1 is "jog", the servo value will reach +100 when pressing PS1 and will back to -100 when loosen. For more details of the switch setting, please refer to [2.2.2 Switch Select](#).

### 1.2.8 Three Position Switch

The four DT buttons can also be used as four 3 position switches by setting. The setting method is as follows:

- (1) Select any DT button for the channel to be set in the "Channel Setting" menu (Take Channel 4, DT1 as an example);
- (2) Enter "Trim/Dial select" menu, and set the step of the corresponding DT button to 100, so that every time the DT button is toggled, the travel amount will go directly to 100. You can also set different values according to your needs.
- (3) After setting, the DT button can be used as a 3-position switch. Return to the home page and toggle the corresponding DT button to check the servo display.

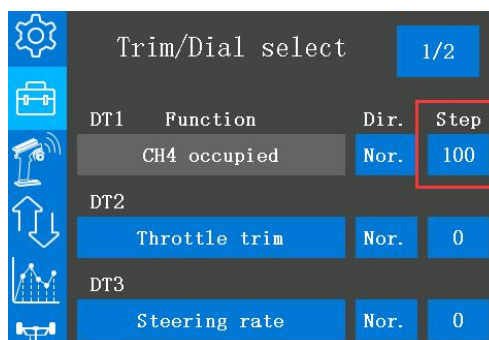
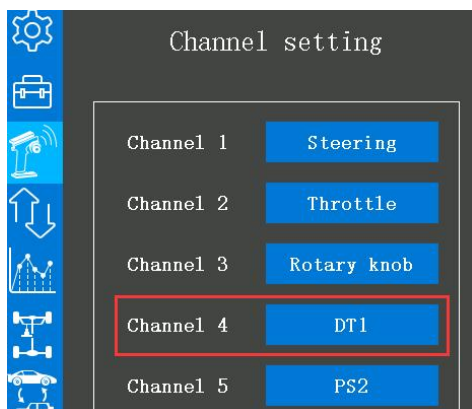

## 1.2.9 Preparation before Turn on Transmitter

### 1.2.9.1 Power for Transmitter

RC8X is easily adapted for various battery layouts with wide operating voltage of 7.2V to 17V, which can use 8 pieces of AAA batteries, a 6S Ni-MH battery or a 2S-4S LiPo battery. Universal JST connector with the voltage protection software of RadioLink ensures vital components are protected from a reverse polarity connection.

#### 1) AAA Battery

- ① Remove the battery cover from the transmitter by sliding it in the direction of the arrow follow the picture at right.
- ② Load 8 pieces new AAA batteries. Pay attention to the polarity markings.
- ③ Make sure the 8 pieces AAA batteries are not loose.
- ④ Slide the battery cover back onto the case.

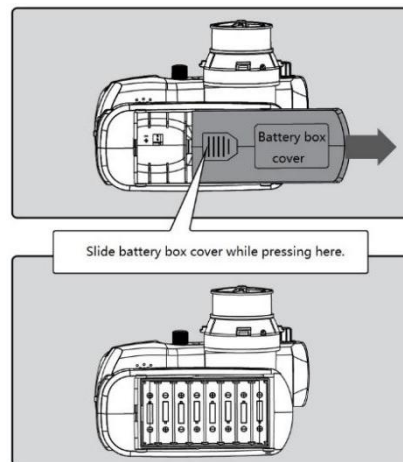

#### 2 ) LiPo Battery

- ① Remove the battery cover from the transmitter by sliding it in the direction of the arrow follow the picture at right.
- ② Remove the battery box.
- ③ Plus a LiPo batteries. Pay attention to the polarity markings.
- ④ Slide the battery cover back onto the case.

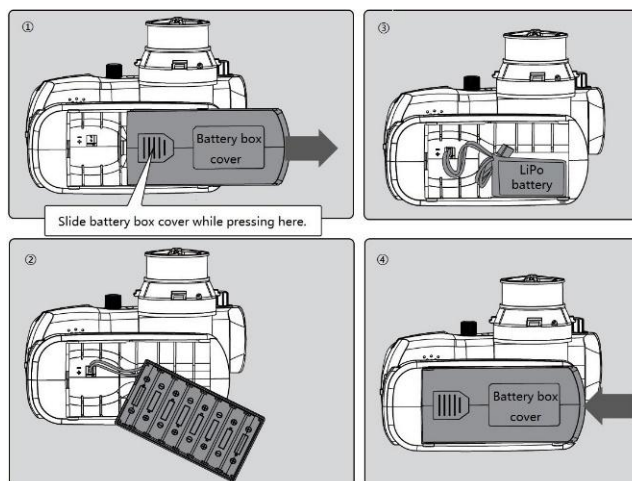

If you use a LiPo battery for power supply, you need to remove the battery box that comes with the RC8X. Please refer to the following two methods to remove the battery box:

- a. Press down one end of the battery box with your thumbs, and the other end will automatically lift up, and then the battery box can be taken out.





b. Use tweezers or other tools to pry one end of the battery box upwards to remove the battery box.



If you need to put the battery box back into the battery tray, please note that the notched end of the battery case faces the PS4 switch direction.



**Attention:** If your RC8X have plug battery already, but still cannot turn on, please check below:

- 1) Check if the AAA batteries have reverse polarity connection.
- 2) Check if the battery box has reverse polarity connection.
- 3) Check if the LiPo battery has reverse polarity connection.
- 4) Check if the AAA batteries have fully charged.
- 5) If the input voltage is lower than 5V, the transmitter cannot be turned on.

### 1.2.9.2 Turn on Transmitter

Long press HOME button about 1.5 seconds, the RC8X will shows RadioLink Logo, and the welcome to RadioLink sound is emitted at the same time, the home page will display this information as the picture below:

① The current model name. There are 200 models in total can be select in Model select menu. Make sure the model name on the display is consistent with the actual model before running. If the model name is not consistent with the actual model, the movement of servo, the steering gear action, the neutral position setting will be wrong, it may be damaging the car.

②  Receiver signal strength. Receiver signal strength will display on the top of the transmitter screen after the transmitter bind success with the receiver.

③ The battery voltage of transmitter.

④ Servo operation from CH1 to CH8. Real-time bar-graph display to demonstrate exactly what commands the transmitter is sending to the servos.

⑤ Mixing function. The background color of functional block will turn to blue if the mixing function corresponding turn on while the background color of functional block will turn to grey if the mixing function corresponding turn off.

⑥ T1 : Total timer. It is used to record the total uptime of the transmitter. Turn off the transmitter will not affect time accumulation.

T2 : Click to time. Click the T2 timer functional block to start to time, stop to time or reset. Click once to start to time, click twice to stop to time, click thrice to reset. The timer set steps can follow: [2.3.4 Timer](#)

⑦ Telemetry.

RX : the current input voltage of receiver.

EXT : the current input voltage of cars or boat.

RSSI : the receiver signal strength, "NULL"

indicate loss of signal or the transmitter and the receiver failed to bind. The RSSI is 0 to 30dBm is normal when the transmitter is apart about 60 centimeters from the receiver, the signal is better the RSSI data is closer to 0. The RSSI test steps can follow: [1.3.7 RSSI Testing](#)

⑧ Button name and its function name and state. The function and value represented by DT1/DT2/DT3/DT4/DL1 can be checked on the home page.

⑨ Into setting menu. Into all the parameter setting menu by press this button.

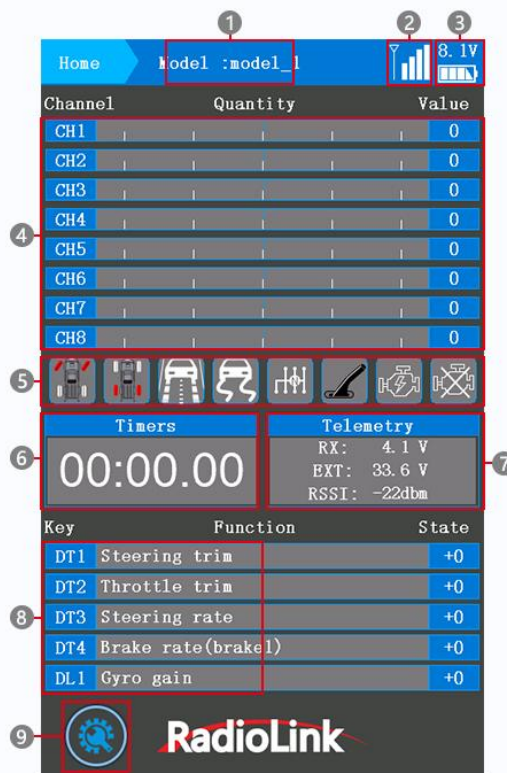

### 1.2.9.3 Language Select















The menu interface is available in multiple languages including Simplified Chinese, Traditional Chinese, English Japanese, Spanish, German and Russian. The menu language of RC8X is English by default, language can be changed in Information Menu.

Setting Steps: turn on your RC8X, click the button at the left bottom of RC8X into System menu, click at the left of RC8X into Information menu, , click the blue select box below the word Language, and then choose the language you want.

Back: click the button or short press the power button to return to the previous menu.





## 1.2.10 Icon Introduction

	Into Setting Menu		Model Select Menu
	System Menu		SD Card Folder
	Tools Menu		Transmitter Version Information
	Basic Menu		Back To Previous Menu
	Telemetry Menu		Increase the value
	Racing Curve Menu		Decrease the value
	Mixing Menu		Reset the value



Click the above icon to enter the menu, and click each function under this menu to set it(check the manual catalogue for functions under each menu).

Example: How to set "End point" ?

Answer: Turn on the RC8X into home page. Click  at the left bottom of RC8X into System menu. Click  into Basic menu, and click End point into the menu to adjust the end point for channel 1 to channel 8. Click "-" to decrease the value, and click "+" to increase the value. Click Reset to restore the current value to the factory default value. After setting finished, click  to return to the previous menu, or short press the power button to the home page.

## 1.2.11 Transmitter Low Voltage Alarm

Transmitter low battery voltage alarm is default 6.8V. If the voltage of transmitter battery is lower than 6.8V, the transmitter will alarm with sound "transmitter voltage low", please change the battery when you heard the alarm, the value of low transmitter battery voltage alarm can be set in the battery menu according to your battery that powered for your RC8X.

Setting steps: turn on your RC8X, click the button  at the left bottom of RC8X into System menu, click  at the left of RC8X into Information menu, click Battery, click the blue select box at the right of Alarm voltage to change the alarm value, click "-" to reduce the number and click "+" to increase the number. If you use a 2S LiPo battery to power for your RC8X, then the alarm voltage number do not lower than 7.4V (for 2S LiPo battery,  $3.7V \times 2 = 7.4V$ ), 3S LiPo battery do not lower than 11.1V, 4S LiPo battery do not lower than 14.8V.

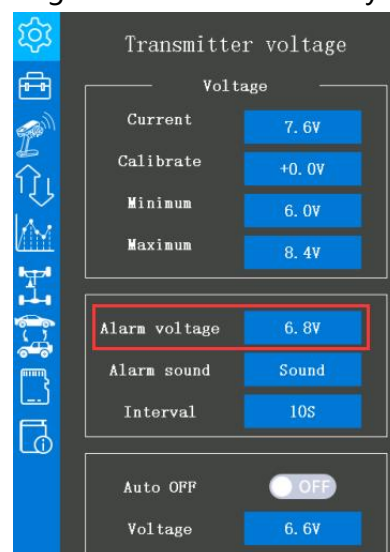



**Attention:** the other parameter setting steps in the Battery menu can follow: [2.1.5 Battery \(Transmitter Battery Voltage\)](#)

## 1.3 Receiver Introduction

### 1.3.1 Features of R8FG

RC8X, packed with a R8FG, 2.4GHz 8 channels receiver, gyro integrated and high voltage servo supported. FHSS spread spectrum algorithm and 67-channel pseudo-random frequency hopping make the R8FG get excellent anti-interference performance, perfect for multiplayer complete synchronously. R8FG also support PWM, SBUS, PPM signals output.

The gyro function (Green LED) of R8FG is turned off by default. If you want to turn on the gyro function, please follow the setting steps: [1.3.5 Gyro Function of R8FG](#)

### 1.3.2 Binding

RC8X and R8FG have finished binding by default. Turn on the RC8X and the R8FG, the signal tower will show on the top of the screen as the picture below, it means the transmitter and receiver has finished binding.

But if you buy a new receiver for your RC8X. Each receiver has an individual ID code and must bind with transmitter before using. When the binding is done, the ID code will be stored in the transmitter and there's no need to rebind.

#### Binding steps:

- ① Put the transmitter and the receiver close to each other (about 60 centimeters). Note: The close distance of the transmitter and receiver may cause signal block, which leads to unsuccessful binding or signal loss.
- ② Turn on both the transmitter and the receiver, and then the LED of R8FG will start flashing slowly.
- ③ There is a black binding button (ID SET) on the side of receiver. Press the button for more than 1 second and release, the LED will flash quickly, indicate binding process is ongoing.
- ④ When the LED stops flashing and is always on, binding is complete and there will be a signal tower shown on top of the LCD screen of the transmitter(As shown on the above). If not succeed, the LED will keep flashing slowly to notify, repeat the above steps.



### 1.3.3 Receiver Connection

#### 1.3.3.1 Connect Cable



The connection wire for receiver is shown in the picture above. The common ones are white/red/black wire or yellow/red/brown wire. The two types of servo cables both are the light-colored wire as the signal wire, the dark-colored wire as the ground wire, and the middle is 5V power supply, and the three wires correspond to "  $\square \sqcup + -$  " .

**Note:** RadioLink receivers are all designed with anti-polarity connect protection. When the servo cable is plugged reversely, the receiver will not work. The receiver operating voltage is 3V-12V. When the receiver uses a separate battery for independent power supply, the receiver will not be damaged if the battery polarity is reversed, but if the servo is connected at this time, it will cause damage to the servo.

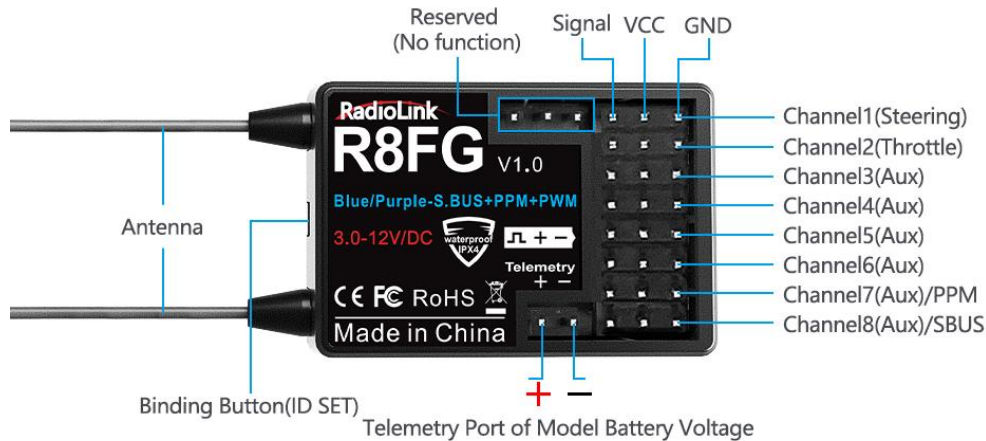

### 1.3.3.2 How to Connect R8FG Correctly for Telemetry

R8FG supports telemetry of model battery voltage, receiver voltage and RSSI. The model voltage will display by connecting the wire to the ESC, battery, and Telemetry port of receiver R8FG. Telemetry of maximum 8S battery(33.6V) supported. Model battery voltage telemetry can be easily achieved by connecting the male end of the battery wire to ESC while the female end to the battery and the wire with a JST head connects Telemetry (+-) of R8FG as below picture shown. No extra module is needed. Once connect with success, the returned model voltage will be displayed on the interface of returned flight information. The connection is as shown below.

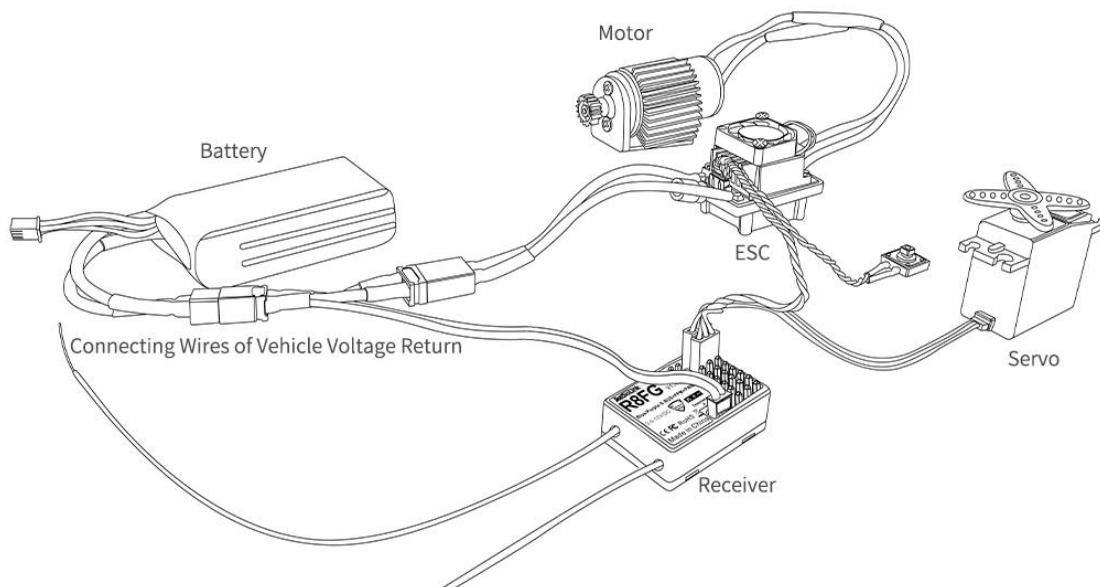

## Attention:



1. Reverse polarity protection circuit design for all 8 channels of R8FG ensures vital components are protected from a reverse polarity connection. But, the JST connector which packed with R8FG for connect to battery cannot reverse polarity connect, or it will lead to the wrong voltage value telemetry.

2. Telemetry port is only used to model voltage telemetry. It can not be used to power the receiver.



### 1.3.3.3 Low Model Voltage Alarm Setting

The low model battery voltage alarm is default 6.6V, if the voltage of model battery is lower than 6.6V, the transmitter will alarm with sound "low engine battery voltage", please replace the battery when you heard the alarm, the value of low engine battery voltage alarm can be set in the Telemetry menu according to your battery that powered for your model.

Setting steps: turn on your RC8X, click the button  at the left bottom of RC8X into System menu, click  into Telemetry menu, click Sensor setting, click the blue select box named EXT voltage to change the alarm value,

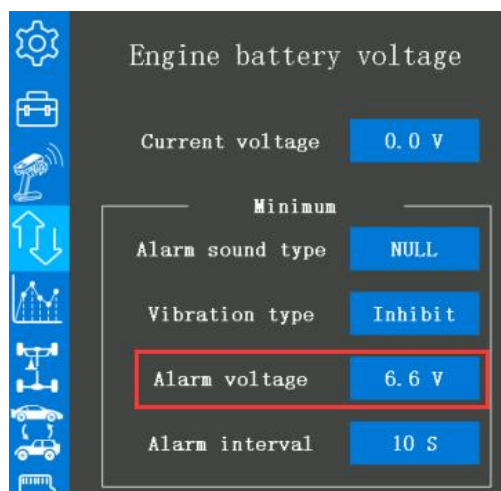

click "-" to reduce the number and click "+" to increase the number. If you use a 3S LiPo battery to power for your model, then the alarm voltage number do not lower than 11.1V (for 3S LiPo battery,  $3.7V \times 3 = 11.1V$ ), 4S LiPo battery do not lower than 14.8V.

Reset: click Reset will make the alarm voltage number back to 6.6V.

Back: click the button  or short press the power button to return to the previous menu.

Current: it defaults 0, if the RC8X bind to receiver success, and connect the telemetry cable to the model battery, the real-time model voltage will show here.

Alarm type: the sound type for alarm, it defaults without any warning tone. But if you want to the RC8X warning you to change the battery when the model battery voltage is lower than the value you have set, there are voice broadcast and 20 types warning tone can be chosen.

Vibration type: it defaults "Inhibit", Mode1, Mode2, and Mode3 can be selected.

Alarm voltage: the low model battery voltage alarm, it defaults 6.6V, the minimum voltage can be set 6V, and the maximum voltage can be set 60V, the low model battery voltage has set depends on the battery you use. Click "-" to reduce the number and click "+" to increase the

number. If you use a 3S LiPo battery to power for your model, then the alarm voltage number do not lower than 11.1V (for 3S LiPo battery,  $3.7V \times 3 = 11.1V$ ), 4S LiPo battery do not lower than 14.8V.

**Alarm interval:** the interval period for alarm, if the model battery voltage is lower than the alarm voltage you have set, it defaults alarm once every 10 seconds, the alarm interval time can be customized.

### 1.3.4 Working Mode of R8FG

R8FG has a built-in gyroscope, which can output not only PWM signal but also PPM and SBUS signals. There are four working modes, including ordinary PWM mode, SBUS mode, Gyro mode, and Gyro + SBUS mode. The channel signal corresponding to each mode are as follows:

R8FG Working Mode						
Working Mode		PWM Mode	SBUS Mode	Gyro mode	Gyro + SBUS Mode	Note
Channel	Telemetry	Telemetry Port of Model Battery Voltage ( + - ) TELEMETRY port is only for 2S-8S battery voltage telemetry. The port cannot be used to power the receiver.				
	1	PWM	PWM	PWM	PWM	Steering
	2	PWM	PWM	PWM	PWM	Throttle
	3	PWM	PWM	PWM	PWM	Aux
	4	PWM	PWM	PWM	PWM	Aux
	5	PWM	PWM	PWM	PWM	Aux
	6	PWM	PWM	PWM	PWM	Aux
	7/PPM	PWM	PPM	PWM	PPM	Aux
	8/S.BUS	PWM	S.BUS	PWM	S.BUS	Aux

### Working mode settings

1 . Turn on/off the gyro: Short press the binding button 3 times within 2 seconds to switch the gyro on and off, and the color of the LED indicator will switch accordingly.

2 . Gyro phase switch: Short press the binding button twice within 2 seconds to switch the gyro phase.

3 . Turning on/off the SBUS: short press the binding button once to turn on/off the SBUS, and the color of the LED indicator will switch accordingly. After SBUS signal is enabled, channel 1-6 output PWM; the seventh channel outputs the PPM signal, and the eighth channel outputs the SBUS signal.

### LED Indicator Color in Different Working Modes

Working Mode	PWM Mode	Gyro mode	SBUS Mode	Gyro + SBUS Mode
Indicator Color	Green	Red	Blue	Red+Blue

Note: When the receiver is connected to the power supply, if there is no successful binding between the receiver and the transmitter or the receiver loses the signal, the indicator of the receiver will flash slowly.

### 1.3.5 Gyro Function of R8FG

R8FG has a built-in gyroscope. The integrated high-performance gyro adopts the software filter and PID algorithm, timely and precisely corrects the sensitivity and improve the stability. Its good flexibility to different models and fields easily achieves professional performance even with drift cars.

#### 1) Enable Gyro

Gyro function of R8FG is turned off by default. Since integrated gyro in R8FG will self-check, it is very important to remain R8FG still when powering it on. When red LED is off means NO gyro.

Press binding button three times (interval less than 1 second), the red LED will flash three times, indicating that gyro is enabled.

#### Attention:

Its normal that the servo keeps shake when connect to receiver, but the transmitter have not operated. Because, the gyro will help to correct the steering gear angle of servo automatically if the gyro function has turned on, you can turn off the gyro function if you do not need this function.

If the receiver has not be moved, but the servo keep shake, there are two reasons as below:

① the servo has connect to the PPM/S.B channel of receiver, please reconnect the servo to the CH1/2/3/4/5/6, because the standard servo only supports PWM signal input.

② the gyro is too much sensitivity, please reduce the value of gyro sensitivity by turn the DL1 knob switch.

#### 2) Gyro Reverse

Set the gyro forward, turn the car right or left to see whether gyro functions. The wheel will turn left when the car is turned right and the wheel turns right when the car is turned left. If the gyro acts counter, press the binding button twice, the red LED flashes twice, the gyro reverse is corrected.

#### 3) Gyro Sensitivity Setup

Gyro sensitivity is default to adjust by channel eight that default controlled by DL1/PS3 knob switch, turning the DL1/PS3 knob switch clockwise to increase sensitivity and anti-clockwise to reduce.



When turning the DL1/PS3 knob switch, tooltip with yellow background color will pop out at the top of the screen, and the value of channel will be changing at the same time, the value is closer to +100, the higher sensitivity. If the value is 0, it means the gyro function have turned off.

If you want set DL1/PS3 to control other function, you can set another switch such as PS1 to as the Gain switch





setting in the “Channel setting” menu.

Setting steps: turn on the RC8X into home page, click the button  at the left bottom of RC8X into System menu, click  into Mixing menu, click the blue select box named Gyro mixing. Click  at the top right corner and then Gain switch to assign a switch to control gyro sensitivity.

### 1.3.6 Installment of Receiver Antenna

Please pay attention to the notes below to get the better control distance.

- ① Do not cut or bundle the receiver antenna wire.
- ② Keep the two antennas at a 90-degree angle. (As shown on the right)
- ③ Big models may contain metal parts that influence signal emission. In this case, antennas should be positioned at both sides of the model to ensure the best signal status in all circumstances.

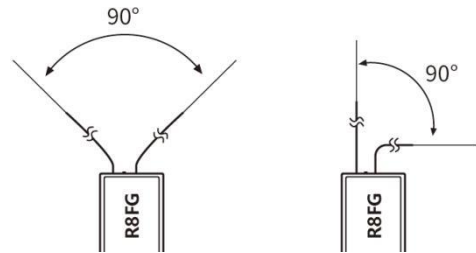

- ④ Antennas should be kept away from metal conductor, carbon fiber, or battery at least half inch away and no over bending.
- ⑤ Keep antennas away from motor, ESC, or other possible interference sources. Do not use a metal receiver antenna holder on a plate made of metal, carbon, or other conductive material. Install the receiver antenna holder as closely as possible to the receiver. Sponge or foam material is advised to use to prevent vibration when installing receiver.
- ⑥ Receiver contains some electronic components of high-precision. Be careful to avoid strong vibration and high temperature. Special vibration-proof material for R/C like foam or rubber cloth is used to pack to protect receiver. Keeping the receiver in a well-sealed plastic bag can avoid humidity and dust, which would possibly make the receiver out of control.

Note: If the receiver needs to be installed in a car/boat with a full metal casing, it is recommended to use an IPEX to SAM with a sucker antenna. The antenna needs to be drawn out, because if the receiver antenna is enclosed in a metal shell, the metal material will affect the signal of the receiver, thereby affecting the control distance.

### 1.3.7 RSSI Testing

If the control distance of cars or boat is short, please refer to this instruction to test the transmitter. This instruction will introduce the test procedure of the transmitter RSSI value and the solution to the abnormal RSSI value.

- ① Turn on the transmitter and power on the receiver at the same time, and then the transmitter and receiver will be connected (if not connected, you need to bind again), the signal tower appears on the transmitter interface, indicating that the binding is successful. The value of RSSI will appear on the Telemetry tooltip, and the RSSI value will keep changing

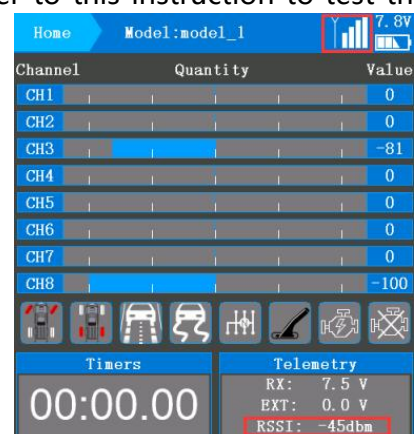

according to the distance between the transmitter and the receiver. (As shown on the right)

② Make the receiver antenna and transmitter antenna parallel, keep transmitter apart from receiver about 60 centimeters and both antennas straight. It is normal that RSSI value is within the range of 0 to -30dBm. The closer the value is to 0, the stronger the signal is. (As shown below)

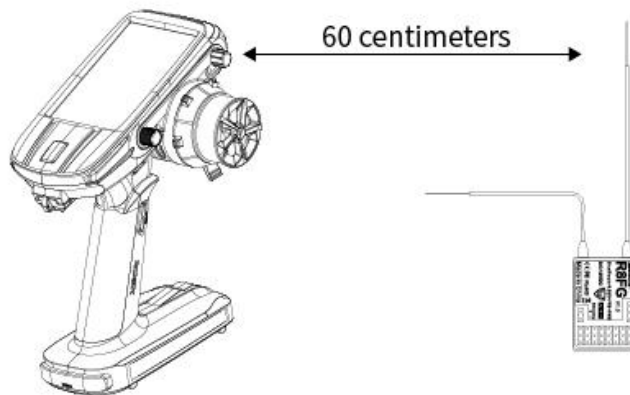

Abnormal signal strength solution:

Check whether the antennas of the receiver and transmitter are damaged. Most signal strength degradation is caused by antenna damage. If it is damaged, the antenna needs to be replaced. If there is no damage, you can test the transmitter and receiver for malfunctions by replacing the receiver. If still cannot solve the problem, email to [after\\_service@radiolink.com.cn](mailto:after_service@radiolink.com.cn) to get support.

## II. RC8X Basic Functions

### 2.1 System menu setting

In System menu, users can set date and time, desktop, system theme, backlight, sound, battery, vibration, LED brightness, home button, external input output, and calibration for wheel, trigger, and rotary knob.

#### 2.1.1 Desktop setting

**Touch timing:** If touch timing is turned on, tap once to start/ stop/reset timing. If touch timing is turned off, none of feedback will received no matter how many taps you give.



#### 2.1.2 System theme setting

In the system theme setting menu, the background color of theme, menu, icon, font can be customized.

**Built-in theme:** the built-in theme refers to the theme that the background and border color have preset. There are five built-in themes in total. Tap the SET button to quickly select the background and border color.

**Custom theme:** at custom theme menu, RC8X users can set the background, border, and font

color by themselves.

The customized colors of theme, background, and font are composed of red, green, and blue. For example, if the values of the three colors of theme are 0, the current border color is black.

**Setting steps:** click Theme, Background, or Font that belong to Custom theme menu in System theme setting menu to set your favorite color. Drag the scale plate to select the color. After confirmed the color of Theme, Background, and Font, click SET to change the color to the secondary color you have select. Click SET button at the right of Theme1 to Theme5 to reset the settings in one second.

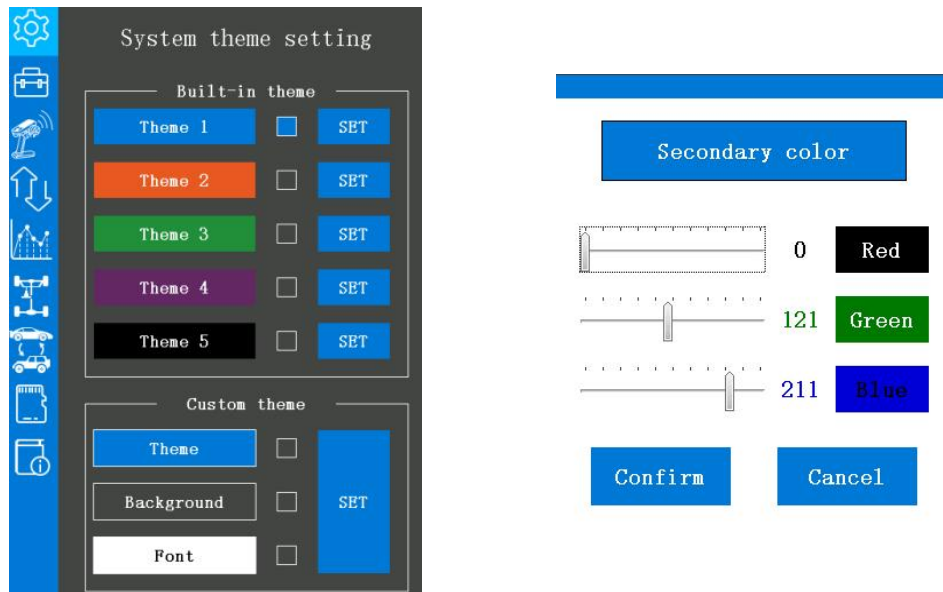

### 2.1.3 Backlight

**Brightness (Always on):** the maximum value of brightness is defaults 100%, tap the value button to adjust the backlight brightness, click “-” to decrease the brightness and click “+” to increase the brightness.

**Brightness (Decrease):** If the time that the touch panel has not operated reached the decreased time you have set, the backlight will turn to the brightness corresponding to the value set here. The original value is 50%, 0% to 100% can be set, click “-” can decrease the brightness, and click “+” can increase the brightness.

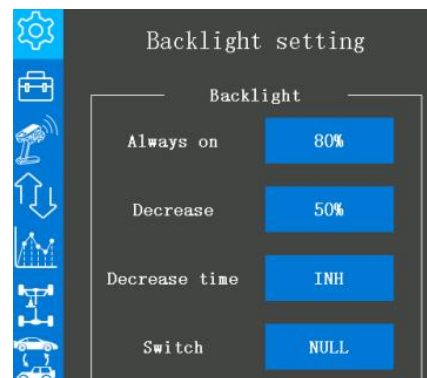

**Decrease time:** The backlight decrease time function is default inoperative. Users can set a period to decrease the LCD backlight. The decrease time counts the period that the touch panel has been not operated. When the time that the transmitter stops operating reaches the decrease time you have set, the brightness will automatically dim according to the brightness ratio set in the above **Brightness (Decrease)**.

**Switch:** User can set a switch to turn on or turn off the backlight, PS1, PS2, PS3, PS4, PS5, Steering, Trigger can be select as the switch. Turn off the backlight when you have finished the parameters setting can save battery power.



**Attention:** to avoid the switch is invalid, before select the brightness control switch, please into the Channel setting menu (belong to Basic menu) to check if the switch has set for other function already, make sure that set an idle switch to trigger the backlight on or off.

## 2.1.4 Sound

### Voice mode:

**Silence:** turn off all the sound if the voice mode select silence.

**Alarm only:** only broadcast the warning notes that have preset. When the current value same as or smaller than the preset alarm value, the RC8X will broadcast the warning notes, the other operation such as press switch or tap function button will do not trigger any sounds. For example: you have set the transmitter will alarm with sound when the receiver signal is -85 dbm, if the current signal is or less than -85 dbm, the transmitter will broadcast "low receiver signal" to warning.

**Without key tone:** no voice when press the switches and tap the function buttons only. The other prompt tones are work normal.

**All:** all the prompt tones are working.

**Normal volume:** This function can set the volume of all the prompt tone such as "operation", "warning", "tap button", "telemetry" etc. The volume is defaults 30%, the minimum volume is 0% which indicate the sound function off, and the maximum volume is 100%.

**Warning volume:** The warning sound means the audible alarm sound of when switch, dial, home button, and trim are operated. The volume of warning sound is default 100%, it can be adjusted.

**Voice volume:** This function can set the volume of voice broadcast. The volume is default 100%, and the minimum volume is 20%.

**Duration:** Refers to the duration of a single prompt tone. L\*1 indicate the shortest duration and L\*4 indicate the longest duration

**Frequency+:** Refers to the softness of the prompt tone. The minimum frequency is default F+0Hz and the maximum is F+200. The lower the value, the softer the sound, and the higher the value, the sharper the sound.

### Press button to broadcast:

**All the content:** When the user triggers the functions that have preset with voice broadcast consecutively or simultaneously, the transmitter will broadcast all the operations in turn. No matter how many operations you have done, the broadcast will start after you have finished the first operation.

**The 1st & last operate content:** Only broadcast the first operation and the last operation if the operations are consecutively. But, if the operation starts during the second broadcast, it will broadcast the first, the second, and the last operation.

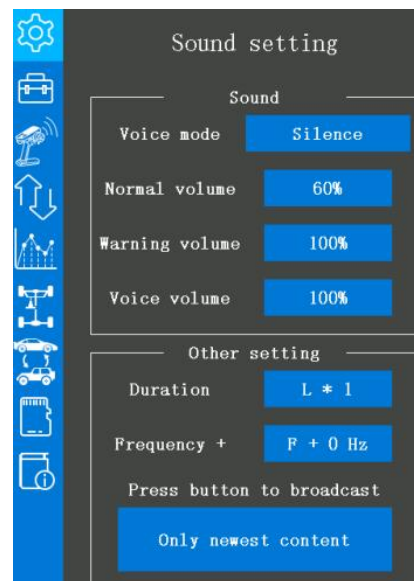

**Only newest content:** only the latest operation will be broadcasted. The speech will be interrupted by the newly triggered content and then the transmitter will go to broadcast the latest content.

## 2.1.5 Battery (Transmitter Battery Voltage)

**Current:** the real-time transmitter battery voltage will display here when the transmitter is powered by a battery.

**Calibrate:** to make the voltage of the battery is consistent with the voltage displayed by increasing or decreasing the calibrate voltage value.

**Minimum:** The lowest operating voltage is default 6.0V. The transmitter will stop working if the battery voltage is lower than 6.0V. The minimum operating voltage can be adjusted according to the battery. It can be adjusted from 5V to 17V. If the battery is a 2S LiPo, then the minimum operating voltage is suggested that not be lower than  $3.7V \times 2S = 7.4V$ , 3S LiPo battery do not lower than 11.1V.

**Maximum:** The highest operating voltage is default 8.4V. It can be adjusted from 5V to 17V.

**Alarm voltage:** The low transmitter battery voltage alarm is default 6.8V. The transmitter will broadcast with "transmitter voltage low" when the transmitter battery voltage is lower than the alarm voltage, please change the battery when you have heard the alarm.

**Alarm sound:** The transmitter will alarm with a voice or a sound effect if the transmitter battery voltage is lower than the alarm voltage you have set. The alarm sound can be adjusted.

"NULL" indicates without any sound if the transmitter battery voltage is lower than the alarm voltage you have set.

"Sound" indicates the transmitter will broadcast with voice or other 20 types of sound effects if the transmitter battery voltage is lower than the alarm voltage you have set.

**Interval:** The interval period for alarm is default 10 seconds. If the transmitter battery voltage is lower than the alarm voltage you have set, the transmitter will alarm once every 10 seconds. The interval period can be adjusted from 10 seconds to 3600 seconds.

**Auto OFF:** "ON" indicates the transmitter will turn off automatically when the transmitter battery voltage is lower than the turn off voltage you have set.

**Voltage:** If the transmitter battery voltage is reached to the voltage you have set here, and the Auto OFF button is ON, the transmitter will turn off automatically. The auto off voltage is default 6.6V. It can be adjusted from 5V to 17V.

**Attention:** Please set the auto-off voltage according to your battery. The auto-off voltage set too high will lead to the battery is not being used effectively, while too low will lead to your battery being over-discharged.

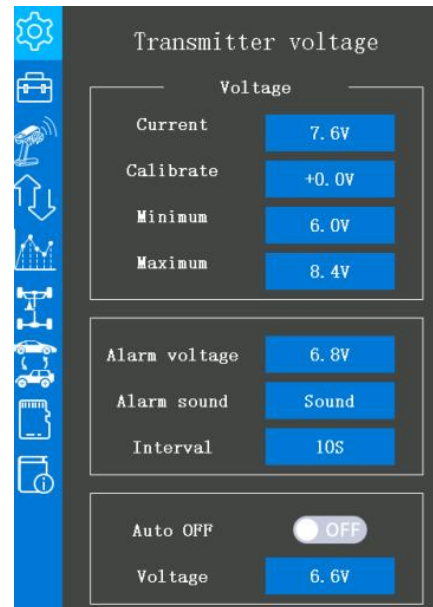

## 2.1.6 Vibration setting

**Vibration by touch:** The word is ON, and the select box's background color is blue indicate the vibration function is turned on. The word is OFF, and the select box's background color is grey indicate the vibration function is turned off. The vibration function is default turn off. If the vibration by touch function is turned on, the transmitter will vibrate accompanied by the sound you have preset when you tap the screen and warn.

**Touch sense:** The touch sense is default 20%, it can be adjusted from 10% to 100%. Users can hardly feel the vibration if they set the value of touch sense to 10%, the larger the value, the stronger the vibration. Click “-” can decrease the value and click “+” can increase the value.

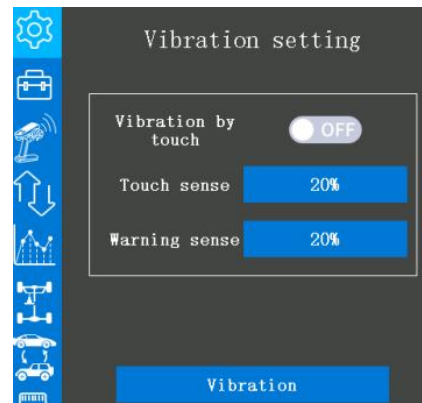

**Warning sense:** The warning sense is default 20%, it can be adjusted from 10% to 100%. Users can hardly feel the vibration if they set the value of warning sense to 10%, the larger the value, the stronger the vibration. Click “-” can decrease the value and click “+” can increase the value.

## 2.1.7 LED setting

LED refers to the LED strips on the left and right sides of the transmitter.

**Brightness :** If the LED type is selected as "Always On", the brightness of the LED strips on the left and right sides of the transmitter can be adjusted. Its default is 90%, can be adjusted from 0% to 100%. The larger the value, the brighter the light. This setting does not affect the "breathe and backlight brightness" mode.

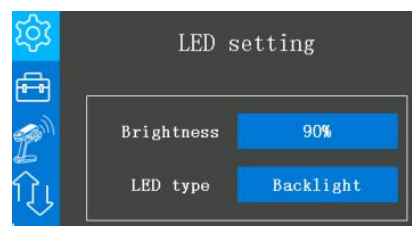

**LED type:** there are three types to select, that are "Always on", "Breathe", and "Backlight".

**"Always on" :** The LED strips on the transmitter's left and right sides will always keep on according to the brightness you have set.

**"Breathe" :** The LED strips on the transmitter's left and right sides will brighten and dim automatically on a regular basis.

**"Backlight" :** At this mode, the LED lights on both sides of the transmitter will follow the brightness setting of the screen backlight. If the backlight is turned on, the LED strips will turn on automatically.

## 2.1.8 HOME button setting

**Push:** Short press the home button can make it be a shortcut key to switch between the current setting page and the main interface of the transmitter.

**Long press:** Press the home button for about 1.5 seconds to turn on or turn off the transmitter.

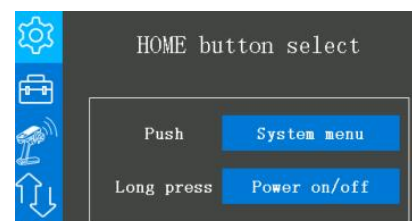

### 2.1.9 External input output

This function is mainly for the DSC multi-protocol port (the signal output mode setting when using equipments such as simulator, trainer cable, head track, Crossfire, 5.8G image transmission and so on ), USB port, multimedia port working mode selection of RC8X.

**Multi-protocol output mode:** mainly for the signal type required by the device connected to the DSC port of the transmitter.

**PPM\_IN:** When the DSC port is connected to the goggles FPV with head tracking function, select this signal mode;

**PPM\_OUT:** Select this signal mode when the DSC port is connected to the simulator or trainer cable;

**SBUS:** When the DSC port is connected to a device that needs to be controlled by the SBUS signal, select this signal mode;

**CRSF:** When the DSC port is connected to TBS Crossfire, select this signal mode.

**Multimedia Mode:** Mainly for the working mode setting of the headphone jack of RC8X.

**Audio output:** select this mode when headphones are plugged into the headphone jack.

**Video input:** select this mode when the headphone jack is inserted into a 5.8G video transmission module or other AV analog video signal equipment.

Note: When the cable of 5.8G image transmission module is successfully inserted into the headphone jack and the USB port, and the image transmission module has been successfully paired with the camera of 5.8G image transmission module, the RC8X screen will automatically split the screen up and down. The upper screen is the menu interface of the transmitter, and the lower screen is the shooting screen of the FPV camera. One screen is dual-purpose and does not interfere with each other. For details, see the picture on the right.

**USB power output:** The default is automatic, when the USB port of the transmitter is used to connect USB data cable to upgrade firmware or copy data to the transmitter, it is the normal USB mode. When the headphone jack is inserted into the 5.8G image transmission receiver, the USB port will turn on the 5V output, which can supply power to the 5.8G image transmission module.

**pop-up window:** When the headphone jack is connected to headphones and other devices, a pop-up window will pop up on the screen of the transmitter, multi-protocol mode selection (PPM, etc.) or multimedia mode selection (audio output or video input), click and select according to actual needs.

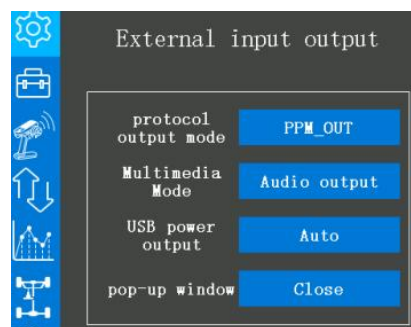



## 2.1.10 Calibration

Wheel, trigger, and Rotary knob correction can be applied when a mechanical offset has occurred for some reason.

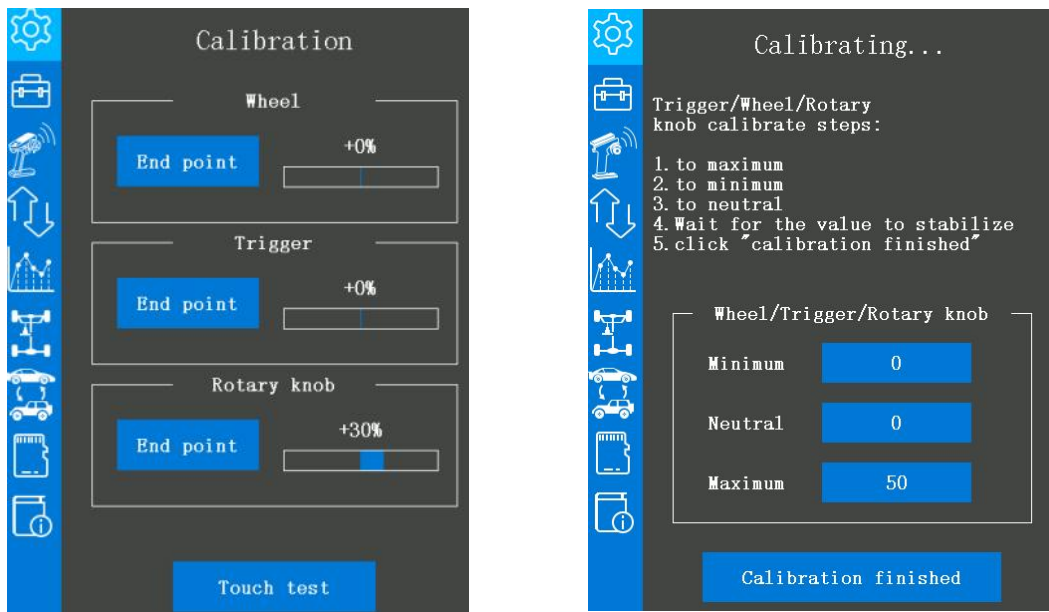

### Wheel: Steering adjustment

Tap "End point" of Wheel into steering calibration menu turn the steering wheel of the transmitter clockwise to the end, and then counterclockwise to the end (As shown on the right), then let it back to neutral automatically, wait until the minimum/neutral/maximum values are stopped to change, and then click "Calibration finished", then the transmitter will automatically return to the "Calibration menu" which means the steering calibration success.



### Trigger: Throttle adjustment

Tap "End point" of Trigger into the throttle calibration menu, pull the throttle trigger to full throttle and the brake position (As shown on the right), then let it go back to neutral automatically, wait until the minimum/neutral/maximum values are stopped to change, and then click "Calibration finished", then the transmitter will automatically return to the "Calibration menu" which means the throttle calibration success.



### Rotary knob: VR button adjustment

Tap "End point" of Rotary knob into the VR button calibration menu, turn the Rotary knob clockwise to the end, and then counterclockwise to the end, then rotate it to the neutral position (As shown on the right), wait until the minimum/neutral/maximum values are stopped to change, and then click "Calibration finished", then the transmitter will automatically return to the "Calibration menu" which means the Rotary knob calibration success.



**Check if calibrate success:** Clockwise and counterclockwise steering wheel or rotary knob to the end to check if the servo value can reach -100% and +100%, pull the throttle trigger to full throttle and the brake position the check if the value can reach to -100% and +100%. If it reaches, the calibration is successful, and if it does not reach -100% and +100%, it indicates a failure, please recalibrate.

**Touch test:** This function can detect whether the touch screen of the transmitter is abnormal. For example, if you find that you cannot click anywhere on the screen during use, you can enter the touch test interface and slowly slide your fingertips on the unclickable area. If the red dot cannot follow your finger, it means the touch screen is abnormal. If the test can't click or the insensitive place can normally appear red dot, it means the weather may be dry, please keep your fingers wet. When the test is completed, please click "Click here to exit the test" in the middle of the screen to return to the calibration menu interface.

**Attention:** The number changed during the calibration is the mechanical quantity of the corresponding switch, so each transmitter is slightly different, please ignore it.

## 2.2 Tools menu

### 2.2.1 Trim/Dial select

**Trim/Dial function select:** This function is used to assign functions for the transmitter's digital trimmer button DT1, DT2, DT3, DT4, and dial button DL1. Click **1/2** at the top right corner to switch the setting menu.

**Button:** DT1/DT2/DT3/DT4: the four digital trimmer buttons on the left side of the wheel. For details of all the buttons, please refer to [1.2.5 Buttons Introduction](#).

**Dir.:** the direction for the four digital trimmer buttons and the dial button, normal and reverse can be selected. If you select Nor., the value will increase when press clockwise the digital trimmer button DT1, DT2, DT3, DT4 or rotate clockwise the dial button DL1. If you select Rev., the value will decrease when pressing anticlockwise the digital trimmer button DT1, DT2, DT3, DT4 or rotate anticlockwise the dial button DL1.

Trim/Dial select				1/2
DT1	Function	Dir.	Step	
	Steering trim	Nor.	0	
DT2	Throttle trim	Nor.	0	
DT3	Steering rate	Nor.	0	
DT4	Brake rate(brake1)	Nor.	0	
DL1	Gyro gain	Nor.	0	

**Step:** indicates the interval of the number change every time the button is pressed. For example, set the Step value to 6, and then each time the DT1 button is pressed, the value will increase or decrease by 6. The value of Step is defaults 2.

**Function 1:** DT1/DT2/DT3/DT4/DL1 can be set to control one of the functions as below: Steering trim, throttle trim, rotary knob trim, flap, dual rate, sub trim channel1/2/3/4/5/6/7/8, acceleration forward/brake1/ brake2/ brake3, steering curve, throttle curve, steering speed turn/return, throttle speed turn(high/middle/low), throttle speed return(high/middle/low), ABS (return brake1/2/3), ABS (delay brake1/2/3), ABS (cycle brake1/2/3), traction control (return /delay/cycle), brake1/2/3 rate, brake EXP(brake1/2/3), brake delay(brake1/2/3), tilt mixing(RUD to FLP), tilt mixing(FLP to RUD), idle up, programable mixing1/2/3/4/5/6/7/8 A/B, 4WS front rate, 4WS rear rate, dual ESC, dual ESC ratio, gyro gain, Ackermann, condition.

**Function 2:** The four DT buttons can also be used as four 3-position switches by setting. For details of setting, please refer to chapter [1.2.8 Three Position Switch](#).

**"NULL"** : indicate that the function is not enabled.

**Note:** After assigning functions to each trim in this menu, if the trim button is selected again when setting other functions, the following prompt "Do you want to replace it?" will appear. If you want the trim button to control the original function, please click "NO"; if you want the trim button to control the new function, please click "YES".

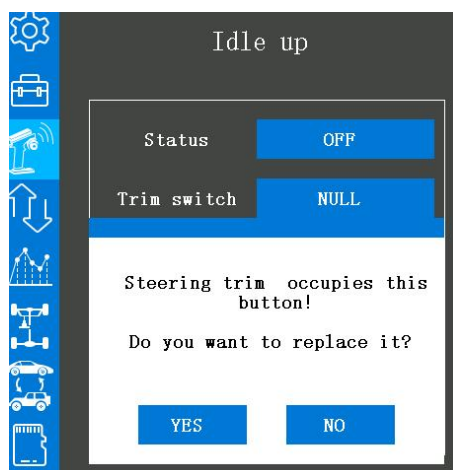

The above picture controls the steering again when setting "Do you want to

is taken as an example. DT1 initially trim by default. If DT1 is selected Idle up function, the above prompt replace it?" will appear. If you click "YES", DT1 will control the Idle up and no longer control the steering trim; if you click "NO", DT1 will still control the steering trim, but not the Idle up function.

### Trim/Dial sound select:

Click **1/2** at the top right corner to switch the setting menu. The sound of button DT1/DT2/DT3/DT4/DL1 can be set in this menu.

**DTxA:** the sound set for pushing the button forward.

DTxB: the sound set for pushing the button back.

Auto: indicate the sound type of the default factory setting.

NONE: indicate without any sound when pressing the button, eight types of beeps can be selected.

Audition: ON means that the audition will be played automatically after selecting the sound, OFF means that the audition will not be played after the sound is selected.

Audio source: indicate the type of sound, "Buzzer", "Warning voice", "System voice" and "Customized voice" can be selected.

Beep1-8: buzzer type, eight types can be selected.

Warning1-20: warning type, twenty types can be selected.

System voice: There are 55 kinds of function voice prompts by default. When the function of the button is set to be the same as the voice function here, you can rotate the corresponding voice broadcast prompt here. For example: After the DT1 trim key is used to control the four-wheel steering, you can select "4wd double" here, and the transmitter will broadcast the voice after selecting it.

Customized voice: Users can make custom prompt voice production through text-to-speech software, and then copy the voice file to the transmitter, where they can choose their own voice. For detailed information on how to make their own voice, please refer to [2.13 Customized Voice Production](#).

Stop audition: The button at the bottom of the screen is OFF, and the background color of the select box is grey, indicating that when selecting the buzzer or warning voice, the transmitter will broadcast the prompt tone that you have selected. The button at the bottom of the screen is ON, and the background color of the select box is blue, indicating that when selecting the buzzer or warning voice, the transmitter will not broadcast the prompt tone that you have selected. This stop audition function only applies to the Key tone-setting menu.

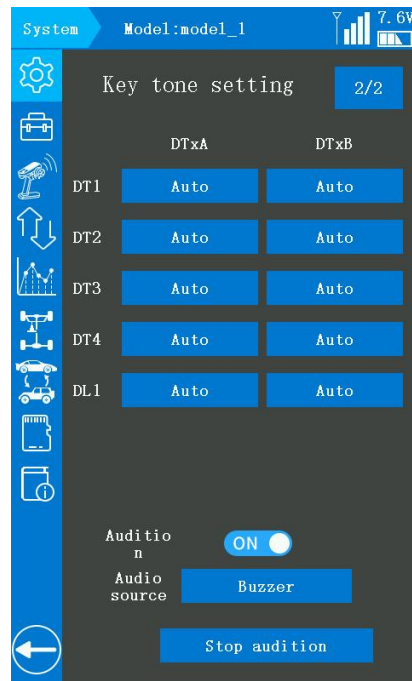

## 2.2.2 Switch select

### Switch select

This function is for function settings of all the PS buttons, steering wheel, and throttle trigger.

Click **1/2** at the top right corner to switch the setting menu. For details of all the buttons, please refer to [1.2.5 Buttons Introduction](#).

Function: PS1, PS2, PS3, PS4, PS5, Steering switch, and Trigger switch can be customized to control the functions as below: Condition1/2, Condition1, Condition2, Condition3,

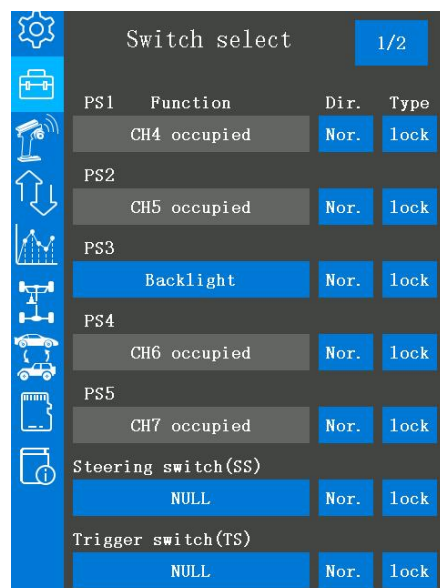



Condition4, Program. Mixing1/2/3/4/5/6/7/8, A.B.S(brake1/2/3), Traction control, 4WS type switching, 4WS type1(front), 4WS type2(reverse), 4WS type3(same), 4WS type4(rear), Dual ESC (front/4WD/rear), Gyro mixing, Gyro gain, Gyro gain group, CPS mixing1/2/3/4, Brake, Start, Engine cut, Idle up, Neutral brake, Timer start, Timer reset, Screen capture, Backlight, Telemetry speech, Stop speech. If you select "NULL" , it means will do not trigger any function except the default function when pressing this button.

**PS1:** The button under the steering wheel, which defaults control CH4, can be customized.

**PS2:** The two buttons on the left and right sides of the handle, which defaults control CH6, can be customized. The two PS2 buttons have the same functions that are convenient for both left-handed and right-handed users.

**PS3:** The rotary knob in front of the steering wheel, the press button PS3 is integrated with the rotary knob DL1. If set this button as PS3, pressing this button will trigger the function that you have set, but rotating this button will not. If set this button as DL1, rotating this button will trigger the function that you have set, but pressing this button will not. PS3 is defaults control the backlight of the transmitter, press once to turn off the backlight and press again to turn on the backlight, can be customized.

**PS4:** The button located at the base of the transmitter, which defaults control CH7, can be customized.

**PS5:** The two buttons on the top left and right sides of the handle, which defaults control CH5, can be customized. The two PS5 buttons have the same functions that are convenient for both left-handed and right-handed users.

**Steering switch (SS):** It defaults control CH1, the rotating of the steering wheel, which can be customized to turn on or turn off other functions when rotating the wheel.

**Trigger switch (TS):** It defaults to control CH2, the forward/brake/back of the throttle, which can be customized to turn on or turn off other functions when triggering the throttle.

**Attention:** (SS) indicates the Steering Switch

(TS) indicates the Throttle Switch

For the position of the switches on the transmitter, please refer to [1.2.5 Buttons Introduction](#)

**Dir.:** Indicate the direction of the buttons, normal and reverse can be selected. Tap the blue select box to set "Nor." or "Rev." , the corresponding servo will display as +100 or -100.

**Type:** lock or jog can be selected.

**lock:** If set the button as a lock button, it can be used as a 2-position switch, press it once to one position, and press it again to the other position.

**Jog:** If set the button as a jog button, the value will reach the maximum (or the minimum) when pressing the button, and back to the original value when loosen. For example: if set the "Dir." of the PS1 is "Nor." and the "Type" is jog, the servo value will reach +100 when pressing the PS1 and the servo value will back to -100 when loosen.

**Nor.+jog:** If set the "Dir." of the button is "Nor." and the "Type" is jog, the servo value will reach to +100 from the original value 0 when pressing the button and the servo value will to -100 when loosen.

**Rev.+jog:** If set the "Dir." of the button is "Rev." and the "Type" is jog, the servo value will reach -100 from the original value 0 when pressing the button and the servo value will to +100 when loosen.

**Nor.+lock:** If set the "Dir." of the button is "Nor." and the "Type" is lock, the servo value will reach +100 from the original value 0 when pressing the button once and the servo value will to -100 when pressing the button again.

**Rev.+lock:** If set the "Dir." of the button is "Rev." and the "Type" is lock, the servo value will reach -100 from the original value 0 when pressing the button once and the servo value will to +100 when pressing the button again.

**Note:** After assigning functions to each switch in this menu, if the switch is selected again when setting other functions, the following prompt "Do you want to replace it?" will appear. If you want the switch to control the original function, please click "NO"; if you want the switch to control the new function, please click "YES".



Take the above picture as an example. PS1 initially controls channel 4 by default. When PS1 is selected again when setting the screenshot switch, the above prompt "Do you want to replace it?" will appear. If you click "YES", PS1 will control the screenshot function and no longer control channel 4; if you click "NO", PS1 will still control channel 4, but not the screenshot function.

## PS buttons sound setting

Click **2/2** at the top right corner to switch the setting menu to Sound setting menu. The sound of button PS1, PS2, PS3, PS4, PS5, PSS, and PTS can be set in this menu.

**Setting steps:** click the blue select box named Auto (because the default factory setting is Auto) can into the sound setting list, select one of the sound types as the prompt tone. You can listen to it when selected, and you can hear the prompt tone every time you press the button after the selection.

**Auto:** indicate the sound type of the default factory setting.

**NONE:** indicate without any sound when pressing the button, eight types of beeps can be selected.

**Audio source:** indicate the type of sound, "Buzzer" and



“Warning voice” can be selected.

Beep1-8: buzzer type, eight types can be selected.

Warning1-20: warning type, twenty types can be selected.

**System voice:** There are 55 kinds of function voice prompts by default. When the function of the button is set to be the same as the voice function here, you can rotate the corresponding voice broadcast prompt here. For example: After the DT1 trim key is used to control the four-wheel steering, you can select "4wd double" here, and the transmitter will broadcast the voice after selecting it.

**Customized voice:** Users can make custom prompt voice production through text-to-speech software, and then copy the voice file to the transmitter, where they can choose their own voice. For detailed information on how to make their own voice, please refer to [2.13 Customized Voice Production](#).

**Stop audition:** The button at the bottom of the screen is OFF, and the background color of the select box is grey, indicating that when selecting the buzzer or warning voice, the transmitter will broadcast the prompt tone that you have selected.

The button at the bottom of the screen is ON, and the background color of the select box is blue, indicating that when selecting the buzzer or warning voice, the transmitter will not broadcast the prompt tone that you have selected.

This stops trial listening function only applies to the Key tone-setting menu.

**Attention:**

PSS indicate that push the steering switch.

PTS indicates the Push throttle switch.

PSxUP: the sound set for the button PS1/PS2/PS3/PS4/PS5 when loosening it.

PSxDOWN: the sound set for the button PS1/PS2/PS3/PS4/PS5 when pressing it.

**2.2.3 Screenshot setting**

Take screenshots for the interface of the transmitter, convenient for users to obtain and share the contents of the transmitters.

**Switch select:** The buttons PS1, PS2, PS3, PS4, or PS5 can be set to trigger the screenshot function.

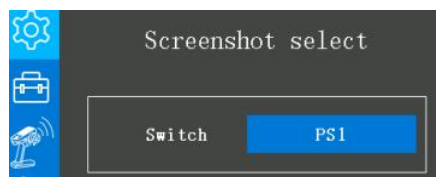

**How to take a screenshot:** Press the switch that you have set in the Screenshot select menu, wait about three to five seconds, “Snapshot successfully!” displayed on the top of the screen indicates screenshot successful. If the “Voice mode” has selected “All” in the Sound menu, the word “Snapshot successfully!” will display with voice broadcast. The screenshot files will save to the folder named “screenshot” on the SD card. The first screenshot picture will default named “Screenshot\_0.bmp” , and the number

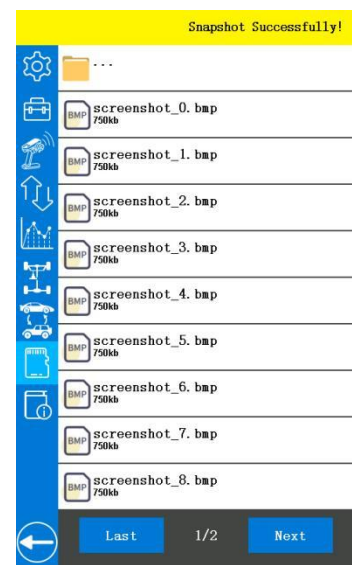

of the file name will increase by one for each additional picture.

**Screenshots preview:** it is not supported to preview screenshots directly in the transmitter. If you want to preview the screenshots, you can connect the transmitter and the computer with a Type-C USB cable, and then preview the screenshots on the computer. Or pull out the SD card and insert it into the card reader, and then insert the card reader into the USB port of the computer to preview the screenshots. (As shown on the right)

**Screenshots preview steps:**

1) connect the transmitter and the computer with a Type-C USB cable, and then press the button PS1 and press the power button at the same time to turn on the transmitter, a tooltip will pop out, if the yellow select box at USB MODE, press the power button to make the USB connect. A U disk will pop out when connecting success.

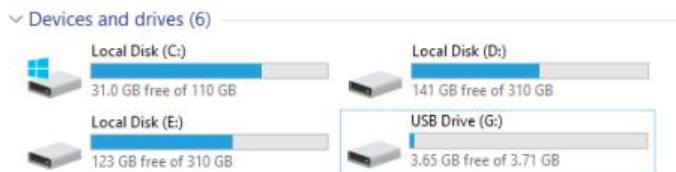

2) click the "screenshot" folder in the U disk to preview the screenshots

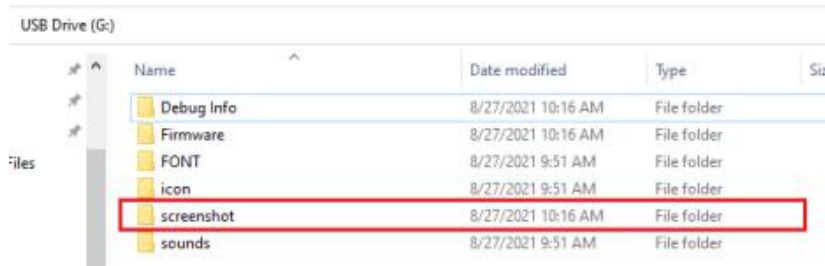

3) click the picture you want to preview

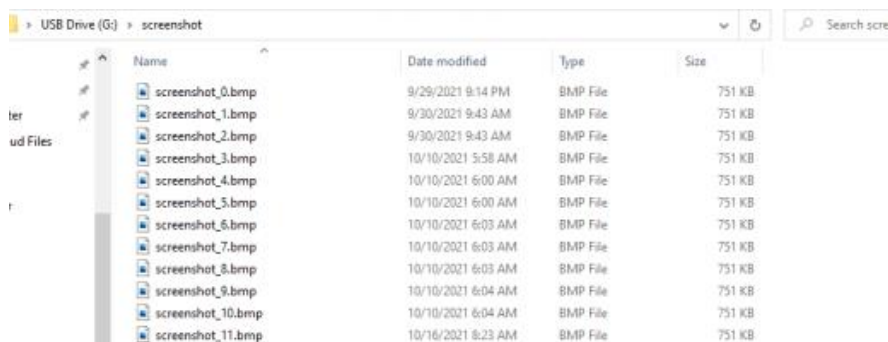

### Attention:

- Do not pull or insert the SD card during taking screenshots.
- It is not supported to rename the screenshots or delete the screenshots directly in the transmitter.
- The charging USB cable that without data transmission function cannot be used to make your transmitter and the computer connects success, please use a USB data cable to connect.
- All files in the SD card only support English, not other languages. If you rename it to another language, the file name will be garbled when you going to preview the screenshots files in the transmitter.
- If the SD card is pulled out and the contents have been modified, you need to insert the

SD card into the transmitter and then restart the transmitter to see the modified content in the SD card.

### 2.2.4 Timer

In the timer setup menu, the alarm time, timer mode, alarm sound type, the switch to trigger the timer, the switch for resetting the timer, vibrator type, and throttle trigger to a timer can be set.

**Alarm time:** the time to trigger the alarm. When the current time reaches the alarm time, the transmitter will alarm. It defaults will alarm at 5 minutes and 0 seconds, which can be customized. The value on the left of M represents minutes, and the value on the left of S represents seconds, which can be customized.

**Attention:** M indicates Minute and S indicates Seconds

**Mode:** the mode for timer, "Up timer" and "Fuel down timer" can be selected, click the blue select box at the right of Mode to set.

**Up timer:** starts at 0 and displays the elapsed time up to 99 minutes 59 seconds.

**Fuel down timer:** starts from the chosen time, displays time remaining, and stops at 0.

**Voice:**

**Type1:** When the timing time reaches the alarm time you have set, the transmitter will vibrate for 2 seconds.

**Type 2:** If the timer function is turned on, there is a sound reminder every second. And, when the timing time reaches the alarm time you have set, the transmitter will vibrate for 2 seconds.

**Start:** the switch to trigger the timer, PS1, PS2, PS3, PS4, PS5, Steering, and Trigger can be selected. If set Steering switch or Trigger switch as the start switch, rotate the SS or push the TS switch to the end to start the timer function.

**Reset:** the reset switch is set for pause timing and reset timer time. If the timer has started, press the reset button once to pause the timer, press the timer again to reset the timer time, that is, to return to 00:00.00.

**Vibrator :**

"NULL" : indicate that the vibrate function is not enabled.

**Type 1:** the transmitter will vibrate about 1 second at the end of the timer.

**Type 2:** If the timer function is turned on, the transmitter will vibrate every second. And, the transmitter will vibrate about 1 second at the end of the timer.

**Throttle trigger:** the function is defaults turn off.

The button at the bottom of the screen is OFF, and the background color of the select box is grey, indicating that no matter pulls or push the trigger will not turn on the timer function.

The button at the bottom of the screen is ON, and the background color of the select box is blue, indicating that when pulls or push the trigger will turn on the timer function.

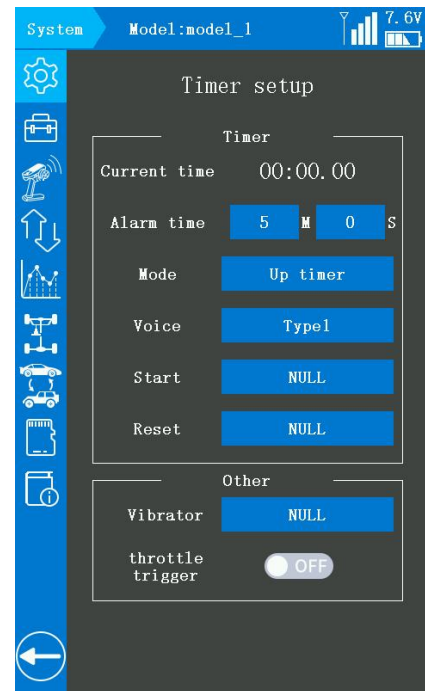



Attention: If the timer start function selects the trigger as the trigger button and the throttle trigger function has turned on, the throttle trigger function will be used first.

### 2.2.5 Lap list

Call lap list when checking the lap memory data (each lap time) memorized by lap timer operation. This function is not available currently, please pay attention to Radiolink official website [www.radiolink.com](http://www.radiolink.com) to get the latest firmware to update this function.



### 2.2.6 Roll out chart

This function is designed for pan cars. The roll out chart can be calculated from input values for the number of teeth of the spur gear and pinion gear, and the tire diameter and displayed as a table.

**Pinion:** Tap the blue select box under Pinion to select the value of the pinion gear, click "-" can decrease the value, and click "+" can increase the value, 10 to 60 can be selected.

**Spur:** Tap the blue select box under Spur to select the value of the teeth of spur gear, click "-" can decrease the value, and click "+" can increase the value, 50 to 130 can be selected.

**Diameter:** Tap the blue select box under Diameter to select the value of the tire diameter, click "-" can decrease the value, and click "+" can increase the value, 40.0 to 100.0 can be selected.

**Step:** Tap the blue select box under Step to set the step of input numerical value of tire diameter amount, click "-" can decrease the value, and click "+" can increase the value, 0.1mm to 1.0mm can be selected.

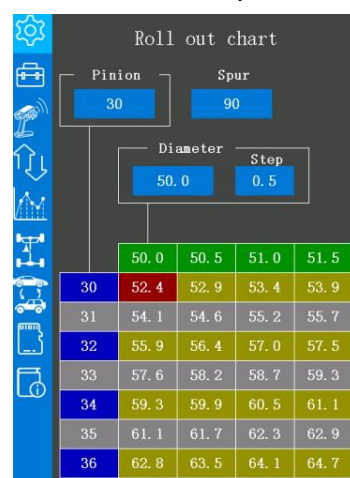

### 2.2.7 Gear ratio chart

The Gear Ratio Chart can be calculated from input values for the number of teeth of the spur gear and pinion gear, and the second gear ratio, and displayed as a table.

**Pinion:** Tap the blue select box under Pinion to select the value of the pinion gear, click "-" can decrease the value, and click "+" can increase the value, 10 to 60 can be selected.

**Spur:** Tap the blue select box under Spur to select the value of the teeth of spur gear, click "-" can decrease the value, and click "+" can increase the value, 0.0 to 100.0 can be selected.

**2<sup>nd</sup> gear ratio:** Tap the blue select box under 2<sup>nd</sup> gear ratio to select the value of the second gear ratio, click "-" can decrease the value, and click "+" can increase the value, 50 to 130 can be selected.

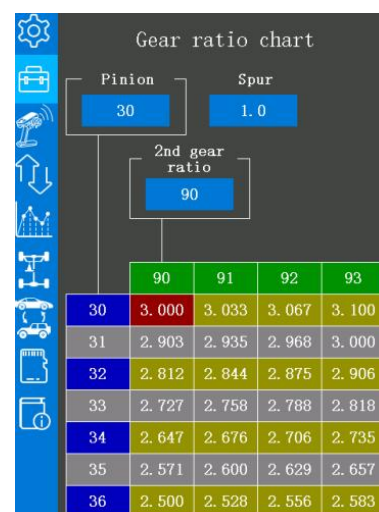

## 2.3 Basic menu

### 2.3.1 Receiver select

Every transmitter has a unique ID code. Before using, binding transmitter to receiver is a must. When binding is finished, ID code will be stored in the receiver, no need to rebind unless the receiver is going to work with another transmitter. If you purchase a new compatible receiver, binding needs to be done before using it. The binding steps can refer to [1.3.2 Binding](#)



**Receiver select:** FHSS V1 receivers have a resolution of 2048, and FHSS V2 receivers have a resolution of 4096. The higher the resolution, the more delicate the angle of servo motion.

You can click "Receivers List" to check whether the receiver you are currently using belongs to this list. If yes, please click the "Select" button next to it to confirm the current receiver type. If not, please do not select this list.

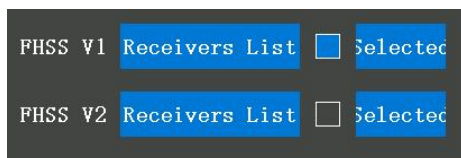

If the receiver list selected here does not include the receiver model you are actually using, the binding may not be successful. For example: You are using the RC8X with R7FG receiver, you need to select FHSS V1 to match the code. If FHSS V2 is selected, binding will not be successful.

**Attention:** The receivers that compatible with the RC8X is keep updating, please pay attention to RadioLink official website [www.radiolink.com](http://www.radiolink.com) to get the latest firmware to check the newly launched receiver. This page is only to display the receiver models which are compatible with the RC8X.

### 2.3.2 Child ID mode

RC8X can bind with multiple receivers. When RC8X and multiple receivers have been bound successfully, and RC8X and all successfully paired devices are turned on at the same time. There are two ways to use them:

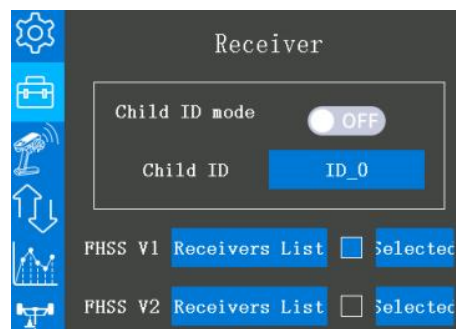

1. When Child ID function is turned off, RC8X can control multiple devices at the same time.
2. When Child ID function is turned on, RC8X can control the specified device according to the selected Child ID. RC8X has 16 groups of Child ID functions, and each ID corresponds to a receiver. Set the Child ID first. When all the devices are turned on, you can control one of the devices through the Child ID function. At this time, the other devices are on standby.

For example: Bind RC8X with a trailer and a trolley and turn all them on. First, use RC8X to control the trolley to run to the trailer of the trailer, and then switch the receiver ID on the trailer to drag the trailer back to the destination.

#### Child ID mode setting steps:

1. Tap the button at the right of the "Child ID mode" to change it from "OFF" to "ON". Set the ID number according to your cars or boats and then finish the bind and parameters set for each receiver.
2. Once finished the Child ID mode setting, the corresponding ID number will be displayed on the main interface of RC8X. (For example: ID\_1) Change the ID number by click "-" or "+", click Reset will make the ID number back to ID\_0.

### 2.3.3 Servo view

Servo operation of channel 1 to channel 8 can be check in this menu.

The servo operations of each channel, such as the steering wheel or the throttle trigger, can be confirmed through the graph moves on this menu. The servo view menu can display the real-time status of each channel in a bar and a numerical value. You can judge whether the output of each channel is abnormal, especially when the programmable mixing function is set.

This menu can directly reflect the operation changes and value changes of the steering wheel, throttle trigger, trim button, or switch. The bars and values displayed on this interface are synchronized with the "servo view" at the top of the main interface.

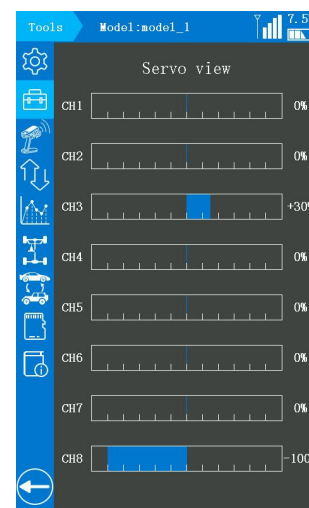

### 2.3.4 Throttle Setting (Trigger)

#### Ratio

Ratio is the function that set for servo neutral. There are three modes can be selected: Forward 50: Brake 50, Forward 70: Brake 30, Forward 100: Brake 0.

This function allows the selection of the forward side and brake (reverse) side operation ratio by changing the neutral position of the throttle servo.

Forward 50: Brake 50: We regard the entire throttle range as 100%. Set the ratio as Forward 50: Brake 50 means that both forward and brake are account for 50%, and the brake is at the midpoint of the throttle range. Release the throttle trigger will not brake, you must keep pull the

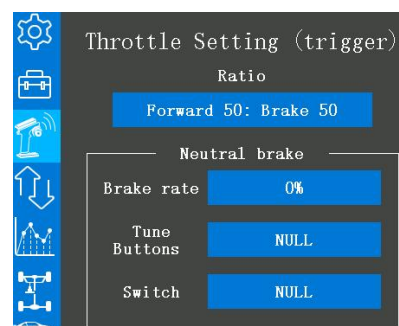



throttle trigger to the brake direction (goes through the midpoint) to brake.

**Forward 70: Brake 30:** We regard the entire throttle range as 100%. Set the ratio as Forward 70: Brake 30 means that the forward is account for 70% and the brake is only account 30% of the throttle range. Release the throttle trigger will not brake, you must keep pull the throttle trigger to the brake direction (goes through the new midpoint which reach to 70% of the entire throttle range) to brake.

**Forward 100: Brake 0:** We regard the entire throttle range as 100%. Set the ratio as Forward 100: Brake 0 means that the forward is account for 100% and the brake are account for 0%, release the throttle trigger and brake immediately. The car cannot go backwards if the Ratio select Forward 100: Brake 0.

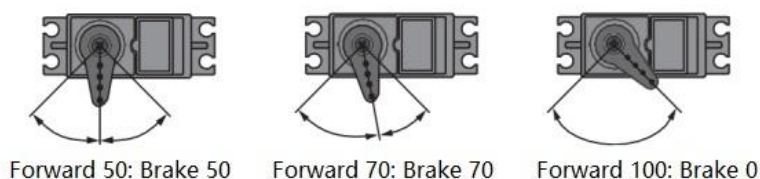

## Neutral brake

The neutral brake function must specify a switch to turn on or off. The brake rate can be set from 0% to 100%. The neutral brake, which applies the brakes at the neutral position of the throttle trigger, can be set. Confirm that the ESC is in the neutral position and the set is in the operation mode before setting the neutral brake function switch to ON.

**Brake rate:** the value of neutral brake rate is 0%, 0% to 100% can be set, the rate value must set depends on the ratio mode.

**Tune Buttons:** DT1/DT2/DT3/DT4/DL1 can be selected to adjust brake rate.

**Switch:** PS1/PS2/PS3/PS4/PS5/Steering/Trigger can be selected to turn on or turn off the neutral brake function. "NULL" : indicate that the function is not enabled.

The ESC neutral brake function and Neutral brake function of Throttle setting can be used simultaneously. However, when setting is difficult to understand, we recommend that only one neutral brake function be used.

When the neutral brake function is "ON", the neutral brake rate adjustment is automatically assigned to the throttle trim (DT1, DT2, DT3, DT4, or dial button DL1).

Throttle side EPA function, or ATL function setting also affects neutral brake side operation. The Idle-up [2.3.11 Idle up](#) or Engine Cut [2.5.9 Engine cut](#) function has priority.

### 2.3.4.1 Cruise Control

Cruise control can keep the throttle output to a fixed value. When cruise control is enabled, the throttle output will jump to the set value regardless of the current position of the throttle trigger. For example, when using RC8X on a climbing car, you can turn on the cruise control with one switch, and the climbing car can maintain a constant speed without pulling the trigger.

**Throttle rate:** The fixed output value of the throttle. The

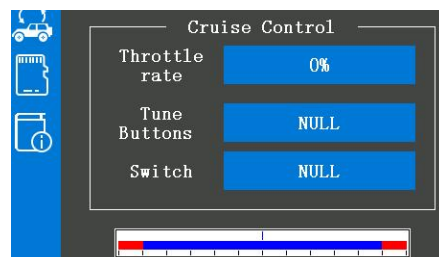

setting range is from 0 to +100%.

Tune Buttons: DT1/DT2/DT3/DT4/DL1 can be selected to adjust throttle rate.

Switch: PS1/PS2/PS3/PS4/PS5/Steering/Trigger can be selected to turn on or turn off the cruise control function.

### 2.3.5 Channel reverse

This function reverses the direction of operation of the servos related to the transmitter's steering, throttle, channel 3, 4, 5, 6, 7, and 8 operations. CH1 to CH8 are default set as R.

**Attention:** "R" indicates REVERSE, "N" indicates Normal.

If the channel has selected reverse, check the control of the corresponding channel on the model to confirm whether the response direction of the device connected to the channel is correct or not.

**Attention:** After the receiver is connected to the ESC, please calibrate the ESC and the transmitter according to the ESC manual, and then operate the throttle trigger, if there is no response, please set Channel 3 from "N" to "R" and then operate the throttle trigger to check whether the throttle channel device responds.



### 2.3.6 Sub trim

Use this function to adjust the neutral position or the entire range of the servo in the set direction of the steering, throttle, channel 3, 4, 5, 6, 7, and 8 servos. The sub trim of each channel is default 0%, -200% to 200% can be selected.

The direction of the steering, throttle, or switch' s operation corresponding to positive and negative values is opposite if the channel set normal (set in Channel reverse menu). After set the sub trim, the neutral position will move to the left/right by a certain percentage. For example: If set the sub trim of Channel 1 as -30%, and the Channel 1 is set normal in Channel reverse menu, then the neutral position of the Channel 1 will move 18 steps to the right.

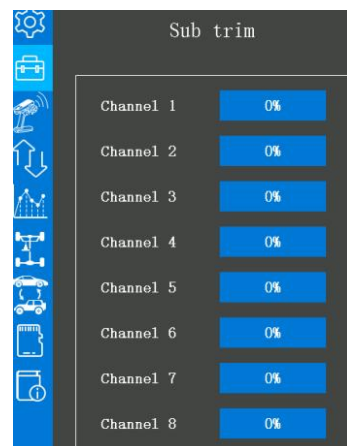

### 2.3.7 End point (EPA)

Use this function when performing left and right steering angle adjustments, throttle high side/brake side operation amount adjustment, and channel 3, 4, 5, 6, 7, 8 servo upside/down side operation amount adjustment.

Correct the maximum steering angle of the left and the right steering angles when there is a difference in the turning radius due to the characteristics of the vehicle.

The left and right sides of each channel can be adjusted

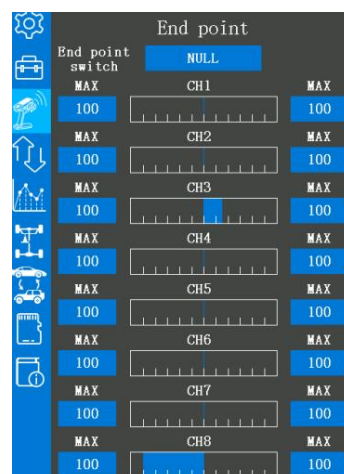

independently, the default value is 100, 0 to 120 can be selected.

### 2.3.8 Fail-safe

This function sets the servo operation position when transmitter signals cannot be received by the receiver for some reason.

The initial value is 0%, which means that when the transmitter signals cannot be received by the receiver, the throttle will stop to output, and the servo will keep its position immediately before the reception was lost.

You can set the value to make the servo move to a preset position you want when the fail-safe function is activated according to your cars or boats. For gasoline engine cars, for safety, we recommend that this fail-safe function be used to set the throttle channel in the direction in which the brakes are applied.

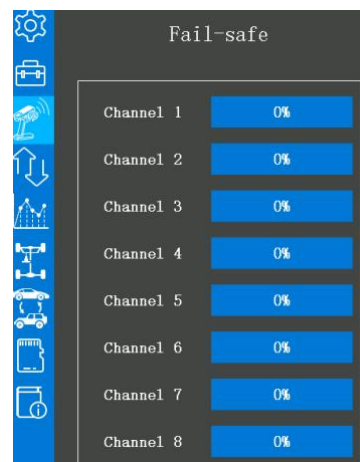

### 2.3.9 Acceleration

**Neutral:** This function is design for adjust the acceleration of throttle when it at the neutral position. Using this function can improve the starting performance of the gasoline engine cars by increasing the neutral speed when the car engine starts. The initial value of Neutral is 0%, -50% to 50% can be selected.

**Forward:** The servo will jump to the input position at its maximum possible speed. Unlike exponential, which adjusts the whole throttle movement into a curve, throttle acceleration simply "jumps" away from neutral and then leaves the remaining response linear.

The initial value of Forward is 0%, 0% to 100% can be selected. 0% means no acceleration and 100% means approximately 1/2 of the forward side throttle angle. Operation near the throttle trigger neutral position becomes a sharp rise if set the value of Forward to 100%.

**Brake1/Brake2/Brake3:** same as the Forward. The initial value of Brake1/Brake2/Brake3 is 0%, 0% to 100% can be selected. 0% means no acceleration when brake and 100% means brake side maximum throttle angle. Operation near the throttle trigger neutral position becomes a sharp rise if set the value of Brake1/Brake2/Brake3 to 100%.

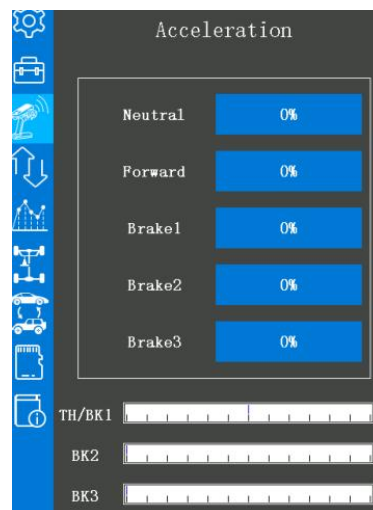

**Attention:** TH indicated Throttle. BK1 indicated acceleration of Brake1, BK2 indicated acceleration of Brake2, BK3 indicated acceleration of Brake3.

### 2.3.10 Condition

This function is not available currently, please pay attention to Radiolink official website [www.radiolink.com](http://www.radiolink.com) to get the latest



firmware to update this function.

### 2.3.11 Idle up

This function is used to improve engine starting performance by raising the idling speed when starting the engine of a GP car/boat. It is also effective when you want to prevent braking when the power is turned off during running because of your gear ratio setting and choice of the motor when operating an electronic car. However, considering safety, and to prevent the motor from rotating instantly when the power is turned on, confirm that the ESC is in the neutral position and the set is in the operation mode before setting the idle up function switch to ON.

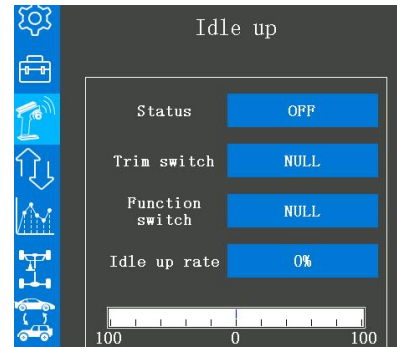

The throttle neutral position is offset to the forward side or brake side. There is no linkage locking, etc. Because there is no change near when the neutral position is offset by this function.

**Status:** to turn on or turn off the Idle up function.

**Trim switch:** DT1/DT2/DT3/DT4/DL1 can be select to adjust the idle up rate, "NULL" : indicate that no switch is set to adjust the idle up rate, but you can also click the value next to the idle up rate in the menu, and then press the [-] or [+] buttons at the bottom of the screen to adjust the rate.

**Function switch:** PS1/PS2/PS3/PS4/PS5/Steering/Trigger can be selected to turn on or turn off the idle up function, "NULL" : indicate that no switch is selected. If the "Status" is set to ON, and the "Function switch" is set to "Null", the transmitter will execute the current idle up rate by default, and it will not automatically turn off.

**Idle up rate:** The rate can be set from -50% to +50%. You can use the trim switch to quickly adjust the idle up rate, or you can click the value next to the idle up rate, and then press the [+] and [-] buttons at the bottom of the screen to adjust the value.

### 2.3.12 D/R, ATL

D/R indicates the steering dual rate function.

The steering left and right servo travels are adjusted simultaneously. This setting is linked to transmitter grip trim DT3. When DT3 is assigned another function, dual-rate can be adjusted with this menu.

ATL indicates the brake rate.

This function decreases the set value when the braking effect is strong and increases the set value when the braking effect is weak. This function is linked to transmitter grip trim DT4. When DT4 is assigned another function, this function can be set with this menu.

**Steering rate:** The initial value of steering rate is 100%, 0% to 100% can be selected. Click "-", "+", or push the trimer button DT3 can adjust the steering effect.

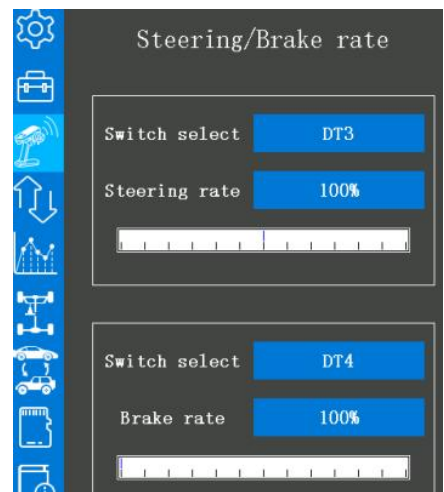

**Steering Rate Switch select:** The initial switch of steering rate is DT3, DT1/DT2/DT3/DT4/DL1 can be selected, select "NULL" indicate that this function is not enabled. Pull or push the DT3 will adjust the value of the steering rate.

**Brake rate:** The initial value of brake rate is 100%, 0% to 100% can be selected. Click "- ", "+" or push the trimer button DT4 can adjust the brake effect.

**Brake Rate Switch select:** The initial switch of steering rate is DT4, DT1/DT2/DT3/DT4/DL1 can be selected, select "NULL" indicate that this function is not enabled. Pull or push the DT4 will adjust the value of the brake rate.

### 2.3.13 Channel limiter

The channel limiter function is to limit the minimum and the maximum servo movement. By superimposing mixing, the linkage can be protected by setting the limiter in case servo motion becomes unexpectedly large.

Different from steering rates and brake rates, each channels' left and right servo travel limits can be adjusted separately. The initial value is 120%, 0% to 120% can be selected.

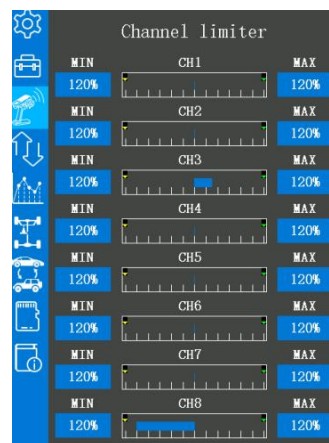

### 2.3.14 Channel setting

Channel 1 to channel 8 can be customized. All the eight channels can be set controlled by Steering, Throttle, Rotary knob, DT1, DT2, DT3, DT4, DL1, PS1, PS2, PS3, PS4, PS5, Steering switch, Trigger switch.

**Channel 1:** It default to control the steering wheel. Steering, Throttle, Rotary knob, DT1, DT2, DT3, DT4, DL1, PS1, PS2, PS3, PS4, PS5, Steering switch, Trigger switch can be set to control the channel1.

**Channel 2:** It default to control the throttle trigger. Steering, Throttle, Rotary knob, DT1, DT2, DT3, DT4, DL1, PS1, PS2, PS3, PS4, PS5, Steering switch, Trigger switch can be set to control the channel2.

**Channel 3:** It default to control by the Rotary knob. Steering, Throttle, Rotary knob, DT1, DT2, DT3, DT4, DL1, PS1, PS2, PS3, PS4, PS5, Steering switch, Trigger switch can be set to control the channel1.

**Channel 4:** it defaults controlled by PS1, the same setting as channel 3.

**Channel 5:** it defaults controlled by PS5, the same setting as channel 3.

**Channel 6:** it defaults controlled by PS2, the same setting as channel 3.

**Channel 7:** it defaults controlled by PS4, the same setting as channel 3.

**Channel 8:** it defaults controlled by PS3, to adjust the Gyro mixing (Gyro sensitivity), turning

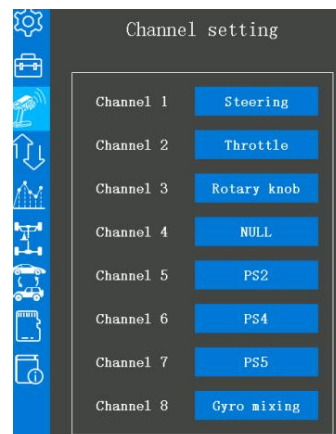



the PS3 knob switch clockwise to increase sensitivity and anti-clockwise to reduce. When turning the PS3 knob switch, tooltip with yellow background color will pop out at the top of the screen, and the value of channel will be changing at the same time, the value is closer to +100, the higher sensitivity. If the value is 0, it means the gyro function have turned off.

## 2.4 Telemetry menu

### 2.4.1 Sensor list

There are 4 kinds of sensors can be set: receiver signal/receiver voltage/transmitter voltage/EXT voltage. Other telemetry functions have not yet been available. If you need to add sensor functions later, you can update the the firmware. Receiver signal, Receiver voltage, Transmitter voltage, EXT voltage can be selected here.

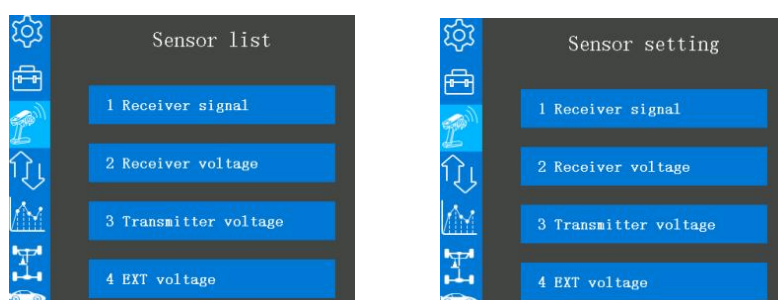

### 2.4.2 Sensor setting

After select the telemetry sensor, the you can set the parameters for each sensor in this menu.

**Receiver signal:** in this menu, the current signal strength (RSSI) of receiver will display, and the low RSSI value alarm mode, the vibration mode, the alarm limit, and the alarm interval can be set.

**Current signal:** the initial value of current signal is -100 dbm. After the RC8X have bind to the receivers which have the signal strength telemetry function, the RSSI value will display here and the value will vary with the distance between the receiver and the transmitter.

**Alarm mode type:** it defaults "NULL" , it means that if the value of current signal is lower than the alarm limit you have set, the transmitter will alarm, sound and 20 kinds of warning can be set.

**Vibration mode:** it defaults "Inhibit" , Mode1, Mode2, and Mode3 can be selected.

**Alarm limit:** the initial low RSSI alarm value is -40dbm, it means if the current signal is less than -40dbm, the transmitter will alarm with sound or warning. The low RSSI alarm value can set from 0 dbm to -100 dbm, the best RSSI alarm value is depending on the control range test.

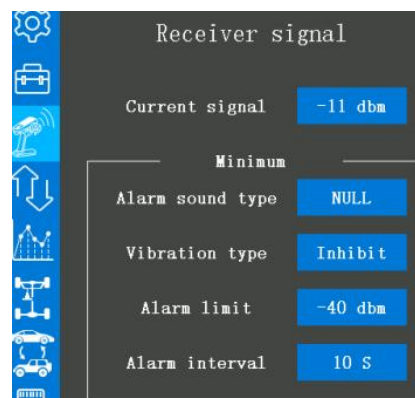

**Alarm interval:** the interval period for alarm, if the low RSSI alarm value is less than the alarm value you have set, it defaults alarm once every 10 seconds, the alarm interval time can be customized.

**Attention:**

1. If the settings has been finished, but the transmitter and receiver are not properly connected, the transmitter will also issue an alarm prompt.
2. When the distance between the transmitter and the receiver is 60 centimeters, it is normal that RSSI value is within the range of 0 to -30dBm. The closer the value is to 0, the stronger the signal is.
3. This function can not only alarm when the receiver signal is weak, but also can be used to test whether the transmitter and the receiver device are communicating normally, the test steps as: <https://www.radiolink.com/newsinfo/561239.html>

**Receiver voltage:** the input voltage of receiver

**Current voltage:** the initial voltage is 0.0V. When the receiver bind success to the RC8X, the current input voltage of receiver will display here.

**Alarm sound type:** it defaults "NULL" , it means that if the current receiver input voltage is lower than the alarm voltage you have set, the transmitter will alarm, sound and 20 kinds of warning can be select.

**Vibration type:** it defaults "Inhibit" , Mode1, Mode2, and Mode3 can be selected.

**Alarm voltage:** the initial voltage is 4.5V, it means that when the current receiver input voltage is lower than 4.5V, the transmitter will alarm, 3.3V to 12V can be selected.

**Alarm interval:** the interval period for alarm, if the current receiver input voltage is lower than the alarm voltage you have set, it defaults alarm once every 10 seconds, the alarm interval time can be customized.

**Transmitter voltage:** please refer to [2.1.5 Battery \(Transmitter Battery Voltage\)](#)

**EXT voltage:** please refer to [1.3.3 Receiver Connection](#)

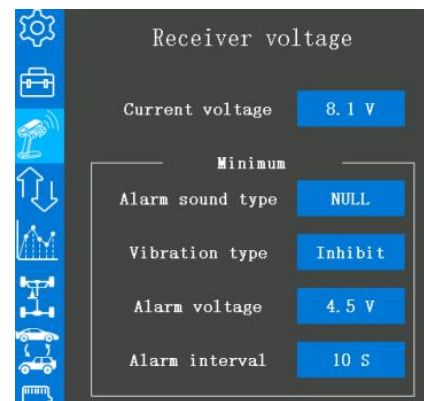

### 2.4.3 Voice

**Auto:** broadcast the sensor status automatically with sound, such as: the current signal strength, the current receiver input voltage, the current transmitter voltage, the EXT voltage etc.

The button at the right of "Auto" is OFF, and the background color of the select box is grey, indicating that the broadcast automatically function is turn off.

The button at the right of "Auto" is ON, and the background color of the select box is blue, indicating that the broadcast automatically function is turn on.

**Switch:** PS1/PS2/PS3/PS4/PS5/Steering/Trigger can be set

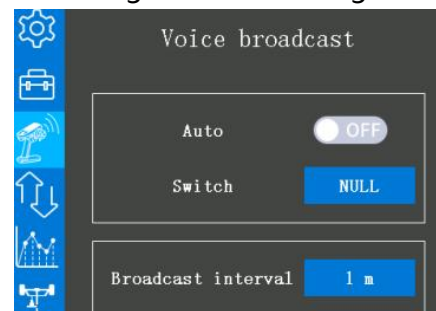

to turn on the sensor status and time broadcast automatically function. If both the sensor status and time broadcast automatically function are turned on, they will be broadcasted according to the order list of the menu.

**Broadcast interval:** the interval period for broadcast, if the sensor status and time broadcast automatically function has turned on, it defaults alarm once every 1 minute, the alarm interval time can be customized.

## 2.5 Racing curve

### 2.5.1 Steering curve

This function is used to change the sensitivity of the steering servo around the neutral position. It has no effect on the maximum servo travel. Also, the "Fine tune" function is which can adjust the rate for left and right separately.

**Type:** EXP (Steering Exponential) and VTR can be selected, it defaults the EXP type.

If the curve type selects EXP, the steering operates will change with a curved curve from the neutral point to the endpoint. While if the curve type selects VTR, the steering operates will change with a linear curve from the neutral point to the high point.

**EXP curve:** It is used to adjust the sensitivity of the direction wheel both in a neutral position and ends. Taking the center line of the EXP as the demarcation point, if set the steering curve type as Quick EXP curve and the EXP rate is 100%, the steering acceleration is completed in the front 80% of the rudder amount range, thus achieving the effect that the first half of the rudder amount changes faster than the second half. The slow EXP curve is the opposite.

**Quick/Slow:** +100 indicates the quick EXP rate, and -100 indicates the slow EXP rate.

The vertical cursor line moves in conjunction with the operation of the steering wheel.

**EXP rate:** the initial value of EXP rate is 0%, -100% to +100% can be selected. With the change of this value, the sensitivity of left and right steering is adjusted in the same ratio.

If you want to make the steering get the higher sensitivity or make steering more gentle, click "+" to increase the value, or click "-" to decrease the value. When the value of EXP is not 0%, click Quick or Slow to switch the value quickly.

**Fine tune(left):** To set the right and left steering curves separately. The initial value is 0%, -200% to +200% can be selected.

**Fine tune(right) :** To set the right and left steering curves separately. The initial value is 0%, -200% to +200% can be selected. Click "-" can decrease the value, and click "+" can increase the value.

**VTR curve:** If the curve type selects VTR, the steering operates will change with a linear curve from the neutral point to the high point. Taking the center line of the VTR as the demarcation point, if set the steering curve type as Quick VTR curve and the VTR rate is 100%, the steering acceleration is completed in the front 80% of the rudder amount range, thus

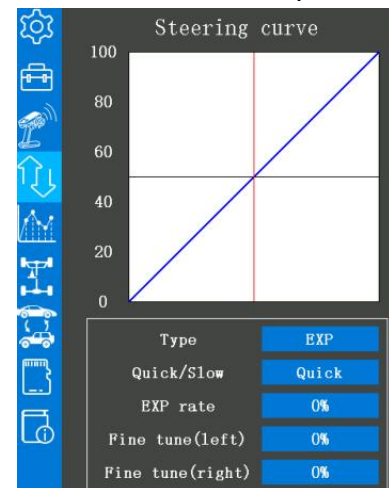

achieving the effect that the first half of the rudder amount changes faster than the second half. The slow VTR curve is the opposite.

**Quick/Slow:** +100 indicates the quick VTR rate, and -100 indicates the slow VTR rate.

The vertical cursor line moves in conjunction with the operation of the steering wheel.

**VTR rate:** the initial value of VTR rate is 0%, -100% to +100% can be selected. With the change of this value, the sensitivity of left and right steering is adjusted in the same ratio.

If you want to make the steering get the higher sensitivity or make steering more gentle, click "+" to increase the value, or click "-" to decrease the value. When the value of VTR is not 0%, click Quick or Slow to switch the value quickly.

**Fine tune(left):** To set the right and left steering curves separately. The initial value is 0%, -200% to +200% can be selected.

**Fine tune(right):** To set the right and left steering curves separately. The initial value is 0%, -200% to +200% can be selected. Click "-" can decrease the value, and click "+" can increase the value.

**VTR point:** The VTR point is set to limit the rudder amount range of the high points. The initial value is 50, which means the high point will reach the half rudder amount range of left or right steering servo, 0 to 100 can be selected.

## 2.5.2 Throttle curve

This function makes the throttle high side direction servo operation quicker or milder. It does not affect the servo maximum operation amount. Throttle curve type: three kinds of curves that EXP, VTR, Multiple point curve can be selected.

**EXP curve:** It is used to adjust the throttle operates change with a curved curve from the neutral position to the high point.

**Quick/Slow:** +100 indicates the quick throttle curve rate, and -100 indicates the slow throttle curve rate. The vertical cursor line moves in conjunction with the operation of the throttle trigger.

**EXP rate:** the initial value of EXP rate is 0%, -100% to +100% can be selected. If you want to make the throttle high side direction

servo operation quicker or milder, click "+" to increase the value, or click "-" to decrease the value. When the value of EXP is not 0%, click Quick or Slow to switch the value quickly.

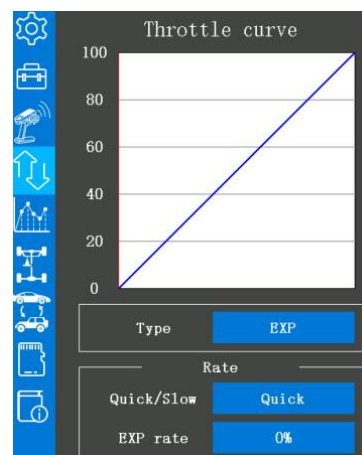

**VTR curve:** It is used to adjust the throttle operates change with a linear curve from the neutral point to the high point.

**Quick/Slow:** +100 indicates the quick throttle curve rate, and -100 indicates the slow throttle curve rate. The vertical cursor line moves in conjunction with the operation of the throttle trigger.

**VTR rate:** the initial value of VTR rate is 0%, -100% to +100% can be selected. If you want to make the throttle high side

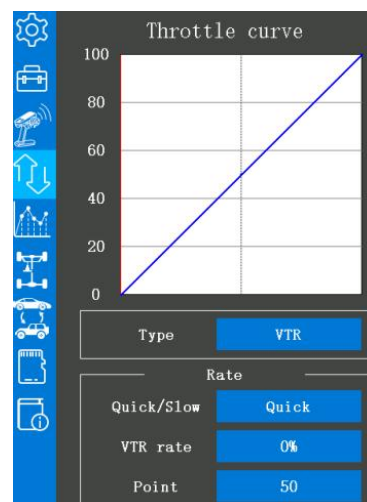

direction servo operation quicker or milder, click “+” to increase the value, or click “-” to decrease the value. When the value of EXP is not 0%, click Quick or Slow to switch the value quickly.

**VTR point:** The VTR point is set to limit the rudder amount range of the high points. The initial value is 50, which means the high point will reach the half rudder amount range of left or right steering servo, 0 to 100 can be selected.

**Point:** When the landform is good and the ground surface has a good grip, set each curve to the plus [+] side (quick rate). When the road surface is slippery and the drive wheels do not grip it, set each curve to the minus [-] side (slow rate).

**Multiple point:** 9 points can be set between the neutral position and the high point.

Point 1 to point 9:

Point 1: the initial value is 10, 0 to 100 can be selected.

Point 2: the initial value is 20, 0 to 100 can be selected.

Point 3: the initial value is 30, 0 to 100 can be selected.

Point 4: the initial value is 40, 0 to 100 can be selected.

Point 5: the initial value is 50, 0 to 100 can be selected.

Point 6: the initial value is 60, 0 to 100 can be selected.

Point 7: the initial value is 70, 0 to 100 can be selected.

Point 8: the initial value is 80, 0 to 100 can be selected.

Point 9: the initial value is 90, 0 to 100 can be selected, click “-” can decrease the value, and click “+” can increase the value.

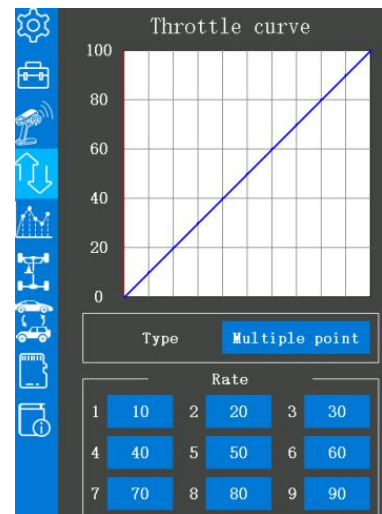

### 2.5.3 Brake curve

This function makes the throttle brake side direction servo operation quicker or milder. It has no effect on the servo maximum operation amount.

Brake curve type: three kinds of curves that EXP, VTR, Multiple point curve can be selected.

If Ratio is set to Forward 100: Brake 0 with the trigger function in **Throttle Setting (Trigger) menu**, the brake side will not operate. Since the setting method of each curve is the same as the throttle (forward) side curve, please refer to [2.5.2 Throttle curve](#)

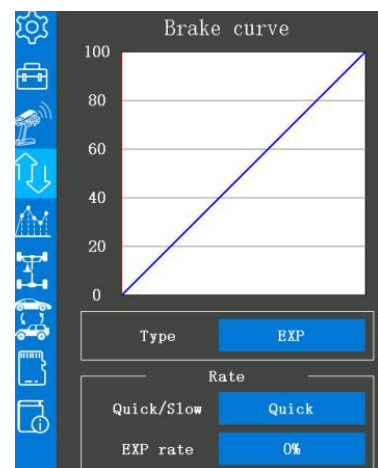

### 2.5.4 Steering speed

Quick steering operation will cause momentary understeering, loss of speed, or spinning. Steering speed

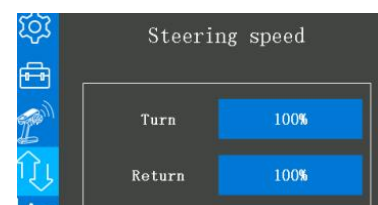



function will very helpful in such cases.

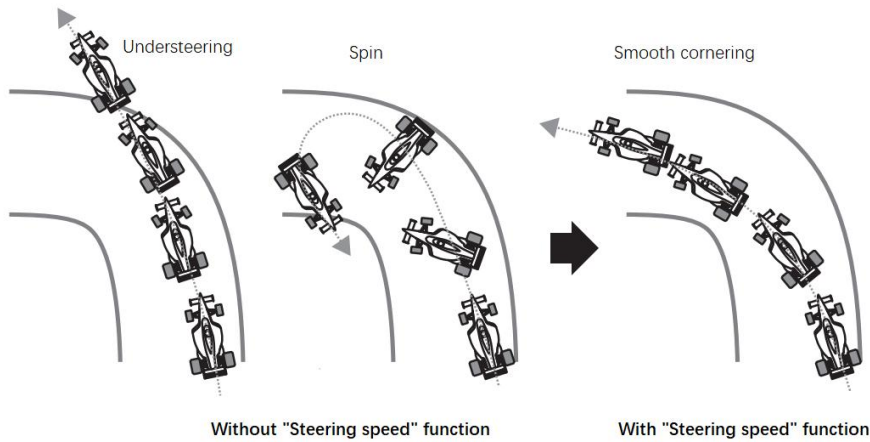

**Turn:** the initial value is 100%, 0% to 100% can be selected. 100% means there is no delay.

**Servo operation is delayed**

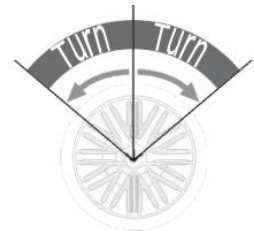

**Return:** the initial value is 100%, 0% to 100% can be selected. 100% means there is no delay.

**Servo operation is delayed**



**Attention:**

1. This function limits the maximum speed of the steering servo. (Delay function)
2. The steering speed when the steering wheel is operated (Turn direction) and returned (Return direction) can be independently set.
3. If the steering wheel is turned slower than the set speed, the steering servo is not affected.
4. The steering speed "Turn" and "Return" adjustment can be controlled with digital trim DT1 to DT4 or digital dial DL1 etc. with the Trim/Dial select function in Tools menu.

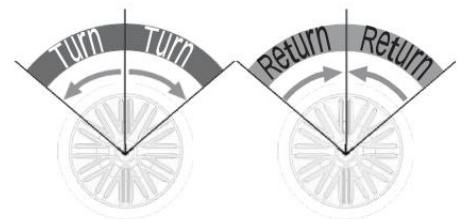

**2.5.5 Throttle speed**

Sudden throttle trigger operation on a slippery road will cause the wheels to spin and the vehicle cannot accelerate smoothly. Setting the throttle speed function reduces wasteful battery consumption while at the same time permitting a smooth, enjoyable operation.

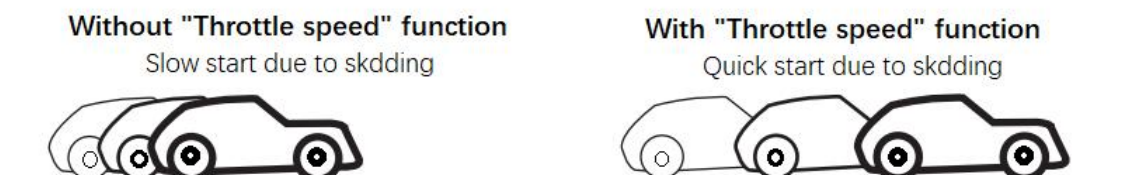

**Attention:**

Throttle servo (ESC) operation is delayed so that the drive wheels will not spin even if the throttle trigger is operated more than necessary. This delay function is not performed when the throttle trigger is returned and at brake operation.

**Mode :** All point, High-Low point, Three-point can be selected.

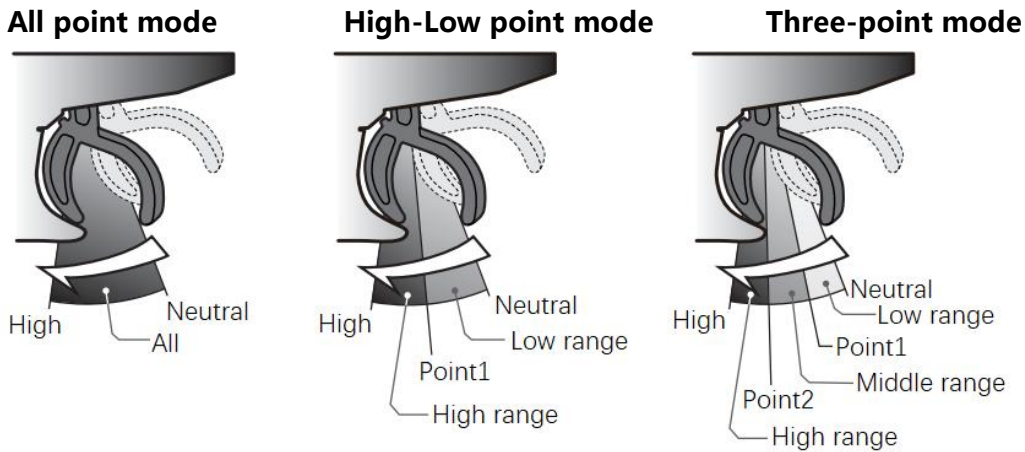

**All point :** A delay is set over the entire throttle range.

**Turn:** the initial value is 100, 1 to 100 can be selected, if the value is 100, it means there is no delay.

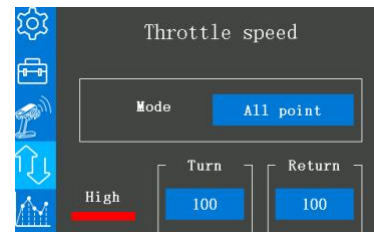

**Return:** the initial value is 100, 1 to 100 can be selected, if the value is 100, it means there is no delay.



**High-Low point :** A delay can be set in 2 ranges with Point 1 as the boundary.

**Turn :** "Low" and "High" turn direction delay adjustment, the initial value of High or Low turn speed is 100, 1 to 100 can be selected, if the value is 100, it means there is no delay.

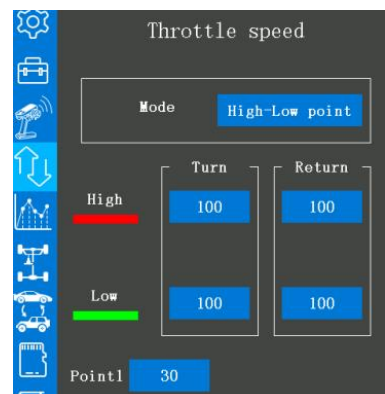

**Return :** "Low" and "High" return direction delay adjustment, the initial value of High or Low return speed is 100, 1 to 100 can be selected, if the value is 100, it means there is no delay.



**Point1:** is for speed switching point adjustment. The initial value is 30, 0 to 100 can be selected to change the "Low" and "High" switching point.

**Three points:** A delay can be set in 3 ranges with Point 1 and Point 2 as the boundaries.

**Turn:** "Low", "Middle", or "High" turn direction delay adjustment. The initial value is 100, 1 to 100 can be selected, if the value is 100 it means there is no delay.



**Return :** "Low", "Middle", or "High" return direction delay adjustment.

The initial value is 100, 1 to 100 can be selected, if the value is 100 it means there is no delay.

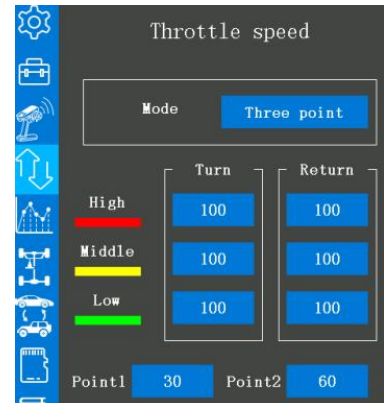

**Point1/Point2:** is for speed switching point adjustment. The initial value of Point1 is 30 and the initial value of Point2 is 60, 0 to 100 can be selected to change the "Low", "Middle", and "High" switching point.

The throttle speed "Turn" and "Return" adjustment can be controlled with digital trim DT1 to DT4 or digital dial DL1 etc. with the Trim/Dial select function in Tools menu.

**Attention:**

Setting the speed function in the return direction slows the deceleration of the car body, so please be careful to set it carefully.

### 2.5.6 Traction control (T.R.C)

Trigger operation with cornering on a slippery road surface is hard to get traction and smooth cornering cannot be done. By intermittently operating the throttle, you can smoothly navigate and travel on topological lines. Also, with a drift car, by intermittently operating the motor in the high point direction, a pseudo reverberator engine sound can be reproduced.

Attention:

1. During throttle operation, the throttle servo is intermittently operated in the forward direction.
2. You can set the amount of return to the slow side, the amount of delay, the speed of pumping, the operating point, and the duty ratio of pumping.
3. You can select the action on the slow side near the neutral and the action on the high point side.

**Mixing:** The button at the right of "Mixing" is OFF, and the background color of the select box is grey, indicating that the

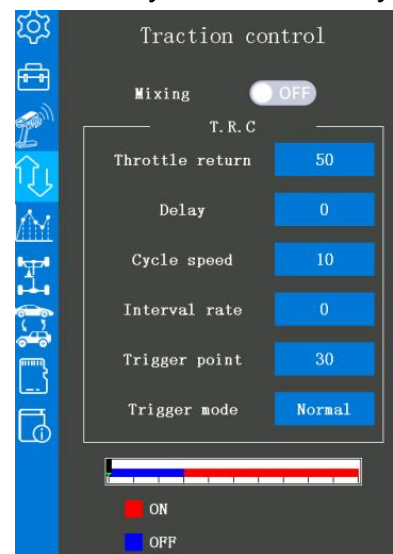

Traction control function is turn off. The button at the right of "Mixing" is ON, and the background color of the select box is blue, indicating that the Traction control function is turn on.

**Throttle return:** Set the ratio that the servo returns to the slow side of trigger operation. If set to 0%, the traction control function will not work. At 50%, it returns to the neutral position at 50% (half), 100% of the trigger operation amount.

**Delay:** Set the delay from when the throttle is operated until when the traction control operation starts. When set to 0%, the traction control function works without delay. At 50%, the traction control function works approximately 0.5 seconds later, and the traction control function works about 1 second later at 100%.

**Cycle speed:** Sets the pulse speed (cycle speed). The initial value is 10, 0 to 30 can be selected. The smaller the set value, the faster the pulse cycle.

**Interval rate:** Set the ratio of the time to operate to the high side and the time to operate to the slow side in the pumping operation. The initial ratio is 0, can be set to +9 - +0 - -9 in 19 steps.

-9 indicates brake application time becomes shortest which means brakes lock with difficulty.

9 indicates brake application time becomes longest which means brakes lock easily.

**Trigger point:** When the traction control mixing is turn on, in the throttle operation, set the position that triggers the traction control function to start to work. The initial value is 30, 5 to 95 can be selected.

**Trigger mode:** Normal or Reverse can be selected.

"Normal" means the high range from the trigger point to the operating range. "Reverse" means the operating range from neutral to trigger point.

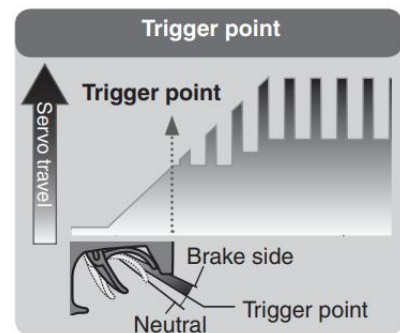

The traction control can be select the switch PS1, PS2, PS3, PS4, PS5, Steering switch, and Trigger switch to turn on or turn off, the switch can select in Switch select menu.

## 2.5.7 A.B.S

When the brakes are applied while cornering with a 4-Wheel Drive or other types of vehicles, understeer may occur. The tendency to understeer can be eliminated and corners can be smoothly cleared by using this function. Three sets of A.B.S can be set. A.B.S function can be turn on or turn off by press A.B.S trigger button or Steering trigger button.

**A.B.S:** The button at the right of "A.B.S" is ON, and the background color of the select box is blue, indicating that the A.B.S function is turn on. Push forward the throttle trigger to trigger the A.B.S function.

**Steering trigger:** The button at the right of "Steering trigger" is ON, and the background color of the select box is blue, indicating that when the vehicle is performing a braking

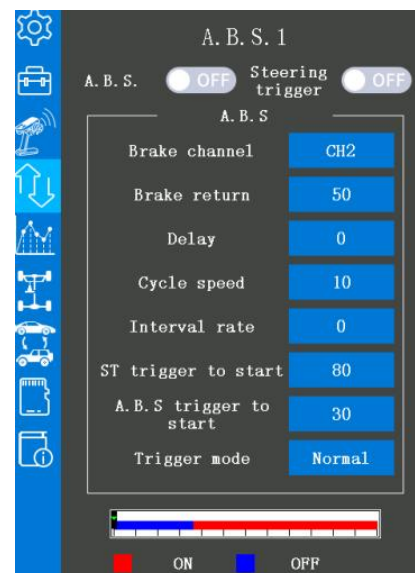

operation while operating steering, and the steering amount is greater than the value of the "ST trigger to start", the A.B.S function will be triggered, if the steering amount is less than the value of the "ST trigger to start", the A.B.S function will not be triggered.

**Brake channel:** A.B.S.1 is default same as the throttle channel, cannot be customized, the channel of A.B.S.2 and A.B.S.3 can be customized, CH1 to CH8 can be selected.

**Brake return:** Sets the rate that the trigger operation corresponds to the servo returns to position when brake release. When set to 0%, the A.B.S function is not performed. When set to 50%, the servo returns 50% (1/2) of the trigger operation amount and when set to 100%, the servo returns to the neutral position.

**Delay:** Sets the delay from brake operation to A.B.S operation. When set to 0%, the A.B.S function is activated without any delay. At 50%, the A.B.S function is activated after a delay of approximately 0.7 seconds and at 100%, the A.B.S function is activated after a delay of approximately 1.4 seconds.

**Cycle speed:** Sets the pulse speed. The smaller the value set, the faster the pulse cycle. The initial value is 10, 0 to 30 can be selected.

**Interval rate:** Sets the proportion of the time the brakes are applied and the time the brakes are released by pulse operation. The initial value is 0, -9 to 9 can be selected.

**ST trigger to start:** steering wheel will trigger the A.B.S function when:

- ① the Steering trigger function is turned on: the button at the right of "Steering trigger" is ON, and the background color of the select box is blue.
- ② the vehicle is performing a braking operation while operating steering
- ③ the steering amount is greater than the value of the "ST trigger to start"

**A.B.S trigger to start:** Sets the trigger point that the A.B.S function is performed. The initial value is 30, 5 to 95 can be selected.

**Trigger mode:** Normal and Reverse can be selected. "Normal" indicates the neutral to trigger point is the range of motion. "Reverse" indicates the range from the trigger point to the full brake side is the operating range.

### Attention:

A.B.S can be independently set for the brakes which are controlled by the Brake 2 and Brake 3 (brake 2 and 3 are auxiliary channels). Brake mixing can be set under the mixing menu. Brake 1, 2, 3 can be adjusted independently except the trigger point of the setting item.

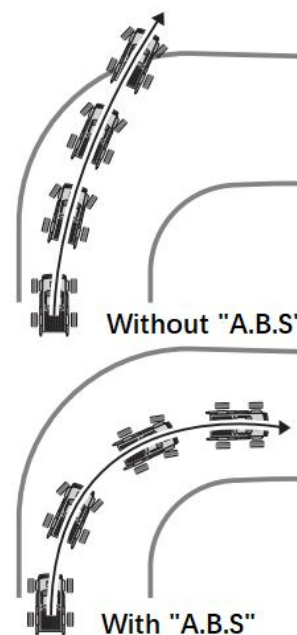

## 2.5.8 Start

If the track is slippery and you begin to accelerate by pushing the trigger to full throttle, the car wheels will spin and will not accelerate smoothly. When the Start function is activated, merely operating the throttle trigger slowly causes the throttle servo to

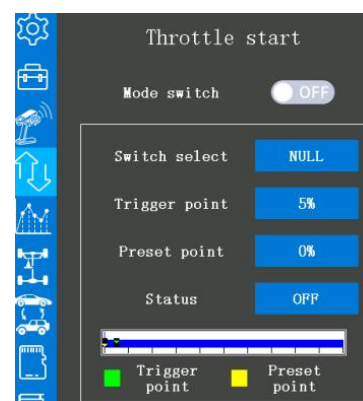



automatically switch from the set throttle position to a preset point so that the tires do not lose their grip and the car accelerates smoothly.

**Attention:**

1. When the throttle trigger moves to the trigger point, the throttle servo moves to the preset point position.
2. This function is effective only for the first throttle trigger operation at starting and must be activated before every start.
3. When the throttle trigger is returned slightly, the Start function is automatically deactivated and the set returns to normal throttle trigger operation.

**Mode switch:** The button at the right of "Mode switch" is OFF, and the background color of the select box is grey, indicating that the Throttle start function is turn off. The button at the right of "Mode switch" is ON, and the background color of the select box is blue, indicating that the Throttle start function is turn on.

**Switch select:** PS1/PS2/PS3/PS4/PS5/Steering/Trigger can be set to turn on or turn off the Throttle start function.

**Trigger point:** When the throttle trigger is moved to the preset position (the value trigger point preset) trigger the Throttle start function. The initial value of Trigger point is 5%, 5% to 95% can be selected.

**Preset point:** When the throttle trigger is operated slowly so that the wheels will not spin. Then, pull the throttle trigger to the value of Preset point, the car will accelerate to the set speed automatically. The initial value of the Preset point is 0%, 0% to 100% can be selected. The throttle trigger the Preset point requires:

- ① The throttle start function is turned on (the Mode switch is ON)
- ② The throttle rudder amount reaches the value of the "Trigger point" .
- ③ The Status is "Ready" .

**Status:** indicates the current throttle start status, "OFF" and "Ready" can be selected, controlled by the switch that set in "Switch select" .In the "Ready" state, if the throttle trigger is operated to the position of the "Trigger point" , the throttle servo will accelerate to the set speed automatically. It is canceled when the throttle trigger is returned.

## 2.5.9 Engine cut

When pressing the Engine cut function switch, the throttle servo will move to the presets position without regard to the throttle trigger position. This is convenient when used to cut the engine of cars, boats, etc.

**Mode Switch:** The button at the right of "Mode Switch" is OFF, and the background color of the select box is grey, indicating that the Engine cut function is turn off. The button at the right of "Mode Switch" is ON, and the background color of

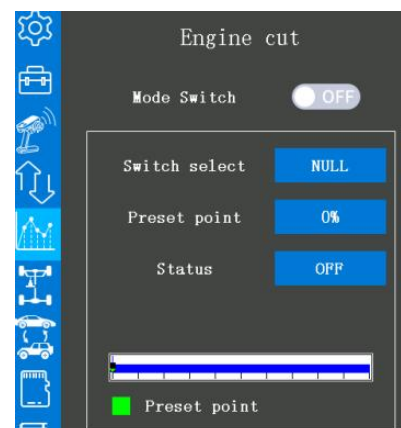

the select box is blue, indicating that the Engine cut function is turn on.

**Switch select:** PS1/PS2/PS3/PS4/PS5/Steering/Trigger can be set to turn on or turn off the Engine cut function.

**Preset point:** the rudder amount when the engine has cut. When pressing the Engine cut function switch with the Engine cut function is turned on, the throttle servo (motor) value is locked in the preset position and does not operate even if the throttle trigger is operated. If the servo was operated in the wrong setting, you may lose control of the car/boat. The initial value of the Preset point is 0%, 0% to 100% can be selected.

**Status:** indicates the throttle state when the engine has cut, "Ready" and "Trigger" can be selected, controlled by the switch that set in "Switch select". In the "Trigger" state, if the Engine cut function is turned on, the throttle servo (motor) value is locked in the preset position and does not operate even if the throttle trigger is operated.

## 2.6 Mixing menu

### 2.6.1 Steering mixing

This mixing function uses 2 servos to control the left and right steering individually. Left and right steering can be set independently to make the cornering smoothly are possible. By using the "Steering mixing" function, the motions of the servos on the left and right sides of the steering can be adjusted at the same time. The right-side steering servo or the left-side steering servo connects to receiver channel 1 and the other side connects to receiver auxiliary channels.

Both left and right servo control channels can be customized. After the left and right servos are adjusted individually, Ackermann can also be adjusted by Ackermann rate. In addition, the left and right steering are operated in the opposite direction by the switch. An emergency brake function by steering can also be set.

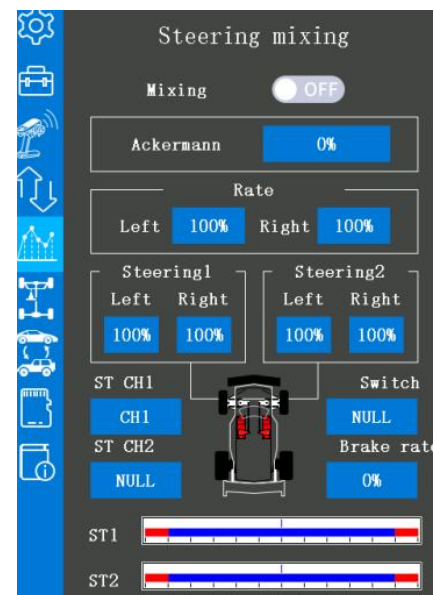

**Attention:** The changes of the rudder amount will display on the bottom of this page (Steering mixing menu).

**Mixing:** The button at the right of "Mixing" is OFF, and the background color of the select box is grey, indicating that the Steering mixing function is turn off. The button at the right of "Mixing" is ON, and the background color of the select box is blue, indicating that the Steering mixing function is turn on.

**Ackermann:** Set Ackermann rate to make the cornering smoother. The initial value is 0%, -100% to 100% can be selected.

**Rate:** is for the left and the right steering mixing rate adjustment. The initial value is 100%, 0% to 100% can be selected.

**Steering 1 :** is for the servo1 steering angle adjustment. The left and the right servo1 steering angle can be set separately. The initial value of left and right is 100%, 0% to 120% can be

selected.

**Steering 2** : is for the servo2 steering angle adjustment. The left and the right servo2 steering angle can be set separately. The initial value of left and right is 100%, 0% to 120% can be selected.

**ST CH1** : is for setting the controlled channel of the servo1. "NULL" indicates that the servo1 is not controlled by any channel, channel 1 to channel 8 can be selected.

**ST CH2** : is for setting the controlled channel of the servo2. "NULL" indicates that the servo2 is not controlled by any channel, channel 1 to channel 8 can be selected.

**Attention:** the servo1 and servo2 controlled channels cannot be occupied, if the channels have been occupied, you need to go to the "Channel setting" menu to set the corresponding channel to "NULL" or select the other channels that have not be occupied.

**Switch:** PS1/PS2/PS3/PS4/PS5/Steering/Trigger can be set to turn on or turn off the Steering brake function.

**Brake rate:** is for the brake angle adjustment. The initial value is 0%, -120% to 120% can be selected.

## 2.6.2 Brake mixing

This function is used when the front and rear brakes must be adjusted independently, for example, in a 1/5 scale GP car. This mixing uses channel 2 to control the rear brakes and the auxiliary channel or auxiliary channel servo to control the front brakes. Or, control channel 2 by the independent throttle and control the rear and front brakes by the auxiliary channel. In addition, mixing which varies the auxiliary channels brake rate in proportion to steering operation is also possible.

**Brake2/Brake3 button:** The button under the "Brake1" or "Brake2" is OFF, and the background color of the select box is grey, indicating that the Brake1/Brake2 mixing function is turn off. The button under the "Brake1" or "Brake2" is ON, and the background color of the select box is blue, indicating that the Brake1/Brake2 mixing function is on.

**Brake channel:** the Brake1 is default controlled by channel2, Brake2 and Brake3 can be customized, channel 1 and channel 8 can be selected.

**Brake rate:** is for the brake rudder amount adjustment. The brake amount of both Brake 2 and Brake 3 can be adjusted individually. The Brake1 brake rate is linked with throttle channel (ATL) setting. The initial value is 100%, 0% to 100% can be selected.

**Brake delay:** is for the delay amount adjustment. The initial value is 0 which means no delay, 0 to 100 can be selected. Since a delay at all the brakes is dangerous, the Brake delay of Brakes 1, 2, and 3 will not be applied at the same time. For example, Brake1, 2, and 3 are all turned on, when a delay is applied to Brake2 and 3, a delay cannot be applied to Brake1. When a delay must

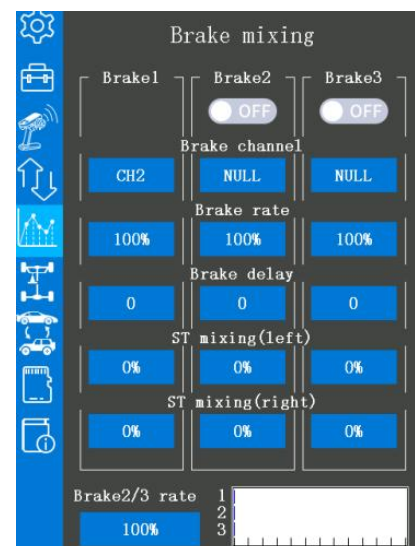

be applied to Brake1, the Brake2 or Brake3 delay must be set to "0".

**ST mixing(left)**: for the left steering mixing adjustment. Use this function when you want to soften the brakes when steering is operated. The initial value is 0%, 0% to 100% can be selected. The smaller the value, the weaker the front brakes. If set the value to "100", the steering mixing is not performed.

**ST mixing(right)**: for the right steering mixing adjustment. Same as the ST mixing(left).

**Brake2/3 rate**: for the Brake1 and 2 amount adjustments.

If trigger ratio is set to Forward 100: Brake 0 with the trigger function in **Throttle Setting (Trigger) menu**, the brake side operation will stop to working. When using the brake mixing function, set the trigger mode to Forward 70: Brake 30 or Forward 50: Brake 50.

### 2.6.3 Gyro mixing

This function can be used to set the built-in gyroscope of the receiver and the external professional car gyroscope function individually. You can use the auxiliary channel switch or button to adjust the gyroscope sensitivity.

#### Gyro mixing 1/2

**Mixing**: The button at the right of "Mixing" is OFF, and the background color of the select box is grey, indicating that the built-in gyroscope function is turn off. The button at the right of "Mixing" is ON, and the background color of the select box is blue, indicating that the built-in gyroscope function is turn on.

**Channel**: the channel to control the built-in gyroscope, it defaults controlled by the channel 8, channel 1 to channel 8 can be selected.

**Gyro type**: Gyro mixing type selection. Gyro built-in, Gain1, Gain2, and Gain4 can be selected.



1) Gyro built-in: it means the current working gyro is the built-in gyroscope of the receiver. How to make the gyro function of the receiver R8FG enabled? Please refer to: [1.3.5 Gyro Function of R8FG](#)

2) Gain1/Gain2/Gain4: to set parameters for the external professional car gyroscope. One of the auxiliary channels can be selected as the gain steering channel. Mounting method and handling about the car gyroscope, please refer to the gyro instruction manual.

**Gain1**: one gain only

**Gain2**: a group gyro gains, can switching from Gain1 and Gain2

**Gain4**: two groups gyro gains, 2 gains can be set in one group, can switching from Gain1 and Gain2, Gain3 and Gain4.

**Gain mode**: Normal and AVSC mode can be selected. The AVCS mode increases straight running stability more than that of the Normal mode. The initial mode is AVSC (the value is 0%), -120% to 120% can be selected, -120% to -1% indicate Normal mode and 0% to 120% indicate AVSC mode.

\* AVCS: Angular Vector Control System

## Gyro mixing 2/2

Click 1/2 at the top right corner to switch the setting menu from built-in gyroscope setting menu to the 2/2 external gyroscope setting menu.

**Current gain:** Group1 and Group2 can be selected, Group1 including Gain1 and Gain2, Group2 including Gain3 and Gain4.

**Gain switch:** DT1/DT2/DT3/DT4/DL1 can be set to adjust the gyro sensitivity, if the Gain switch select as "NULL", it means the gyro sensitivity only can be adjust by clicking the "+" and "-" in **Gyro mixing 1/2** menu.

**Gain group type switch:** if the Gyro group type selected Gain4, a switch should be set to switching between Group 1 and Group 2. PS1 /PS2 /PS3 /PS4 /PS5 /Steering/Trigger can be selected. If the Gain group type switch selects "NULL", then only one group of gyro gain can be selected at a time.

**Gain type switch:** if the Gyro type selected Gain2 or Gain4, a switch should be set to switching between Gain1 and Gain2 or Gain3 and Gain4. PS1/PS2/PS3/PS4/PS5/Steering/Trigger can be selected. If the Gain type switch selects "NULL", then only one gain of each group can be selected at a time.

**Gyro mixing switch:** same function as "Mixing" button at the menu of **Gyro mixing 1/2**.

Click 2/2 at the top right corner to switch the setting menu from the external gyroscope setting menu back to the 1/2 built-in gyroscope setting menu.



## 2.6.4 4WS mixing

### 4WS mixing 1/2

**4WS (4 Wheel Steering):** This function can be used for crawlers and other 4WS type vehicles. It uses channel 1 to control front side steering and one auxiliary channel to control rear side steering.

**Mixing:** The button at the right of "Mixing" is OFF, and the background color of the select box is grey, indicating that the 4WS mixing function is turn off. The button at the right of "Mixing" is ON, and the background color of the select box is blue, indicating that the 4WS mixing function is turn on.

**MIX mode:** The button at the right of "MIX mode" is OFF, and the background color of the select box is grey, indicating that the EXP function of the channel1 and other settings are not mixed. The button at the right of "MIX mode" is ON, and the background color of the select box is blue, indicating that the EXP function of the channel1 and other settings are mixed.

**4WS type:** four types can be selected.

Type1: Function OFF (front only)

Type2: switching between front side only and front side normal but rear side reverse phase

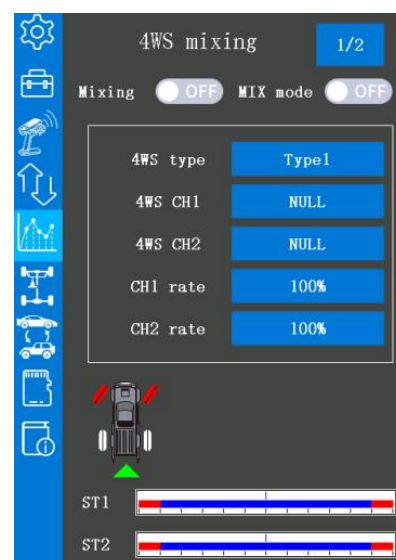



Type3: switching from front side only, front side normal but rear side reverse phase, and the front and rear keep the same phase

Type4: switching from front side only, front side normal but rear side reverse phase, the front and rear keep the same phase, and rear side only

4WS CH1/CH2: CH1 to CH8 can be selected to control the steering servo of the car.

CH1/CH2 rate: to set the front rate or rear rate, the initial value is 100%, -120% to 120% can be selected. Both CH1 and CH2 rate set positive or negative value, the front and rear steering will keep move the same direction, while if the CH1 rate set the positive value and the CH2 rate set the negative value, the front steering and the rear steering will move the opposite direction.

## 4WS mixing 2/2

Click 1/2 at the top right corner to switch the setting menu from 4WS mixing type and rate setting menu to the 2/2 4WS mixing switch select menu.

Front rate: DT1/DT2/DT3/DT4/DL1 can be set to decrease or increase the value of front rate, select "NULL" indicate that this function is not enabled.

Rear mix rate: DT1/DT2/DT3/DT4/DL1 can be set to decrease or increase the value of rear mix rate, select "NULL" indicate that this function is not enabled.

Mode change: PS1/PS2/PS3/PS4/PS5/Steering/Trigger can be selected to switching the four 4WS types (front side only, front side normal but rear side reverse phase, the front and rear keep the same phase, and rear side only).

Front/Reverse/Same/Rear:PS1/PS2/PS3/PS4/PS5/Steering/Trigger can be selected to trigger the 4WS type, select "NULL" indicate that this function is not enabled. For example: if set the Front switch is PS2, when press the PS2, the 4WS type will switch to the type that front side only from other types.

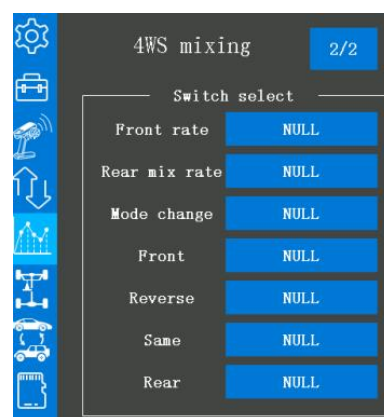

## 2.6.5 Dual ESC mixing

This function is mixing two ESCs used with crawlers and other 4WD type vehicles and uses channel 2 to control the rear motor and an auxiliary channel to control the front motor.

DT1/DT2/DT3/DT4/DL1 can be set to switch from front-drive only, rear-drive only, and both front and rear drive (4WD), or select one of the buttons PS1/PS2/PS3/PS4/PS5/Steering/ Trigger to trigger one of the Dual ESC types.

Trigger ratio is suggested to set as Forward 50: Brake 50.

## Dual ESC mixing 1/2

Mixing: The button at the right of "Mixing" is OFF, and the background color of the select box is grey, indicating that the Dual ESC mixing function is turn off. The button at the right of "Mixing" is ON, and the background color of the select box is

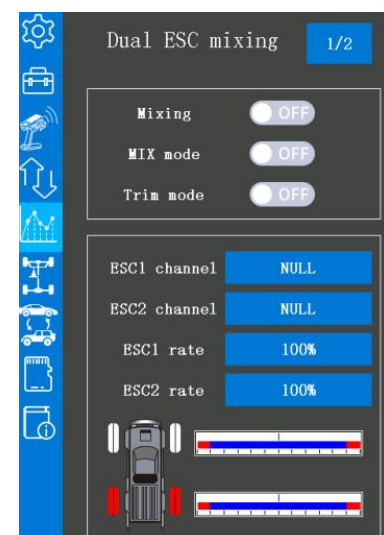

blue, indicating that the Dual ESC mixing function is turn on.

**MIX mode:** The button at the right of "MIX mode" is OFF, and the background color of the select box is grey, indicating that the EXP function of the channel2 and other settings are not mixed. The button at the right of "MIX mode" is ON, and the background color of the select box is blue, indicating that the EXP function of the channel2 and other settings are mixed.

**Trim mode:** The button at the right of "Trim mode" is OFF, and the background color of the select box is grey, indicating that the trim of the channel2 is not mixed. The button at the right of "Trim mode" is ON, and the background color of the select box is blue, indicating that the trim of the channel2 is mixed.

**ESC1 channel/ESC2 channel:** set the controlled channel for ESC1/ESC2, channel1 to channel 8 can be selected.

**ESC1 rate/ESC2 rate:** Adjust the front and rear motor controller operation amount by click "+" and "-", by pressing the button "+" to adjust the rate of ESC2 and by pressing the button "-" to adjust the rate of ESC1 when both the value of ESC1 and ESC2 are 100% (the initial value). Only one of the ESC rates can lower than 100%, for example, if the ESC1 rate is 90% and the ESC2 rate is 100%, you press the button "+" will make the rate of ESC1 increase to 100% first and then decrease the rate of ESC2.

## Dual ESC mixing 2/2

Click 1/2 at the top right corner to switch the setting menu from Dual ESC mixing mode, rate, channel setting menu to the 2/2 Dual ESC mixing switch select menu.

**Dual ESC switch:** DT1/DT2/DT3/DT4/DL1 can be set to switch the Dual ESC (front) and the Dual ESC (rear), select "NULL" indicate that this function is not enabled.

**Drive rate:** the same function as ESC1 rate/ESC2 rate in the **Dual ESC mixing 1/2** menu. DT1/DT2/DT3/DT4/DL1 can be set to adjust the Dual ESC ratio, select "NULL" indicate that this function is not enabled.

**Dual ESC (front)/Dual ESC (4WD)/Dual ESC (rear):** PS1/PS2/PS3/PS4/PS5/Steering/Trigger can be selected to trigger one of the Dual ESC types, select "NULL" indicate that this function is not enabled.

As this function drives 2 separate motors simultaneously, a mutual load will be applied. Use this function carefully so that the motors are not damaged.

RadioLink will not be responsible for motor controller, motor, and other vehicle trouble due to the use of this function.

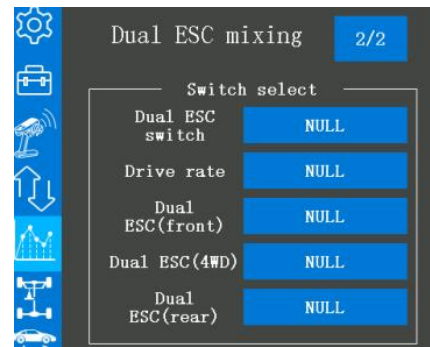

## 2.6.6 CPS mixing

This function can set a switch (including steering wheel and throttle trigger) to trigger the LED turn on or turn off. Channel 1 to channel 8 can be set as the trigger channel or operation.

If the CPS mixing function is on, and select the steering wheel or throttle trigger as the trigger switch, then the LED will turn on, turn off, or blink when steering or push or pull the

trigger. The blink speed and trigger mode can be customized.

### CPS mixing1/2/3/4

**Mixing:** The button at the right of "Mixing" is OFF, and the background color of the select box is grey, indicating that the CPS mixing function is turn off. The button at the right of "Mixing" is ON, and the background color of the select box is blue, indicating that the CPS mixing function is turn on.

**Trigger CH:** set the channel as the trigger channel to turn on or turn off the CPS mixing function. Channel 1 to channel 8 can be selected.

**Operation CH:** the channel to connect the light, channel 1 to channel 8 can be selected. When press the switch that controlled the light trigger channel, the light or turn on or turn off. The operation channel can set same channel as the trigger channel.

**Trigger mode:** Neutral, Left, Right, Both sides, PS switch can be selected according to the trigger switch you have set.

**Point1/2:** the rudder amount to trigger the light turn on or turn off.

**Operation mode:** off till triggered to flash, flash till triggered to off, off till triggered to on, and on till triggered to off can be selected.

**Off till triggered to flash:** the LEDs will keep off till the trigger switch reach the point value you have set that trigger the LEDs flash. The LEDs will keep flash until you trigger the LED to off.

**Flash till triggered to off:** the LEDs will keep flash till the trigger switch reach the point value you have set that trigger the LEDs off.

**Off till triggered to on:** the LEDs will keep off till the trigger switch reach the point value you have set that trigger the LEDs turn on. The LEDs will keep on until you trigger the LED to off.

**On till triggered to off:** the LEDs will keep on till the trigger switch reach the point value you have set that trigger the LEDs turn off.

**Cycle speed:** When "Operation mode" is set to "Flash", the "Cycle speed" can be set to change the LEDs' flash speed. It defaults 50, 1 to 100 can be selected, the smaller the value, the faster the LEDs flash.

**Point1/2:** beside make the trigger switch reach the point value you have set (the point value set below the Trigger mode), point 1 and point2 below the "Cycle speed" must set to trigger the LEDs operation. The value of Point1 is default 0 and the value of Point2 is default 100, the absolute value of Point1 plus the absolute value of Point2 do not less than 95. The details value must depend on your LEDs.

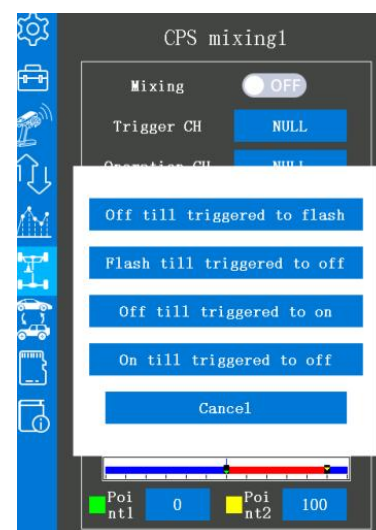
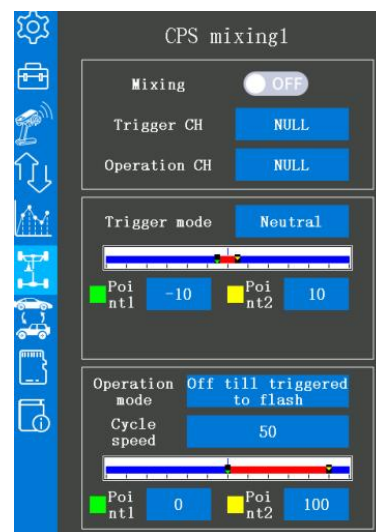

## 2.6.7 Tank mixing

This function is intended for vehicles such as tanks, etc. It can be used for the pivotal turn or the ultra-pivotal brake turn by operating the steering and the throttle.

**Mixing:** The button at the right of "Mixing" is OFF, and the background color of the select box is grey, indicating that the Tank mixing function is turn off. The button at the right of "Mixing" is ON, and the background color of the select box is blue, indicating that the Tank mixing function is turn on.

**Mixing channel:** the channels select to connect the left and right motors.

**Mixing rate (Forward/Back):** is for forward/backward rate adjustment. The throttle channel and the steering channel operate in conjunction with each other. By operating the trigger to the high side, the car body advances as "Forward rate" while if operate the trigger to the brake side, the car body will backward as the "Back rate".

**Mixing rate (Left/Right):** is for left/right side rate adjustment. The throttle channel and the steering channel operate in conjunction with each other. When operating the steering wheel to the right, the car body turns to the right at the "Right rate" pivotal turn while when operating to the left, the car will turn to the left at the "Left rate" pivotal turn.

**Forward limit/Back limit:** It is to limit the maximum operation amount of the throttle channel so that it does not exceed the limit by the influence of the mixing amount.

When steering and trigger are operated at the same time:

- ① If you manipulate the trigger to the high side and operate the steering wheel to the right, the car body will turn to the right side at the rate of "forward" and "right" .
- ② If you manipulate the trigger to the high side and operate the steering wheel to the left, the car body will turn to the left side at the rate of "forward" and "left" .
- ③ Operating the steering wheel while operating the trigger to the brake side will operate the same as the forward side in the reverse direction.

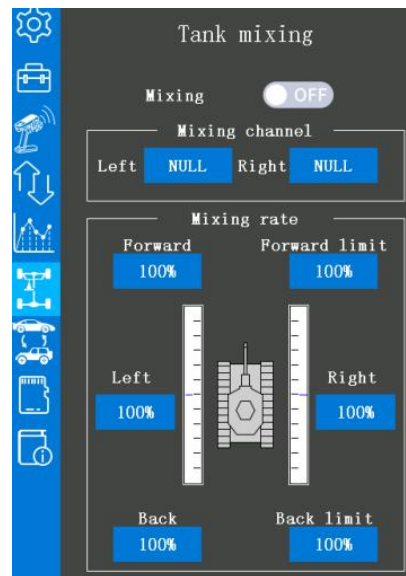

## 2.6.8 Programmable mixing

These functions allow you to apply to mix between the steering, throttle, and auxiliary channels. 8 programmable mixings can be selected. The same function for each programmable mixing.

### Program. Mixing1 1/2

**Curve type:** EXP curve, VTR curve, Multiple point curve can be selected.

#### EXP curve:

**Quick/Slow:** is for the rate of EXP/VTR/Multiple point curve.

0% to 100% indicates the quick EXP/VTR/Multiple point rate, and -1% to -100 indicates the slow EXP/VTR/Multiple point rate. The vertical cursor line moves in conjunction with the changes of the curve rate value.

**Offset:** The master channel mixing center point (the point that the direction changes) can be offset.

**EXP/VTR/Multiple point curve rate:** The initial value is 0%, -100% to 100% can be selected.

**Fine tune(L)/(R):** To set the right and left steering curves separately. The initial value is 0%, -200% to +200% can be selected.

EXP curve, VTR curve, Multiple point curve mixing can be set from master channel to slave channel. For details on how to set each curve, please refer to: [2.5.1 Steering curve](#) and [2.5.2 Throttle curve](#).

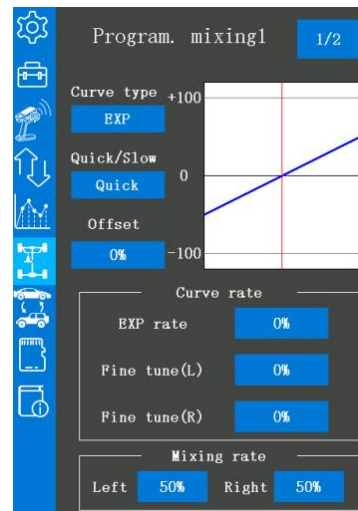

### Mixing rate:

**Left:** for left, forward or upside mixing amount adjustment. The initial value is 50%, -120% to 120% can be selected.

**Right:** for right, brake or down side mixing amount adjustment. The initial value is 50%, -120% to 120% can be selected.

### Program. Mixing1 2/2

Click **1/2** at the top right corner to switch the first programmable mixing setting page to the second programmable mixing setting page.

**Switch select:** PS1 /PS2 /PS3 /PS4 /PS5 /Steering /Trigger can be selected to turn on or turn off the programmable mixing function, select "NULL" indicate that this function is not enabled.

**Mixing:** The button at the right of "Mixing" is OFF, and the background color of the select box is grey, indicating that the Program. mixing1 function is turn off. The button at the right of "Mixing" is ON, and the background color of the select box is blue, indicating that the Program. mixing1 function is turn on.

**MIX mode:** The button at the right of "MIX mode" is OFF, and the background color of the select box is grey, indicating that the EXP function of the channel2 and other settings are not mixed. The button at the right of "MIX mode" is ON, and the background color of the select box is blue, indicating that the EXP function of the channel2 and other settings are mixed.

**Trim mode:** The button at the right of "Trim mode" is OFF, and the background color of the select box is grey, indicating that the trim of the channel2 is not mixed. The button at the right of "Trim mode" is ON, and the background color of the select box is blue, indicating that the trim of the channel2 is mixed. When the steering or throttle channel is the master channel, trim data can be added.





**Mixing channel:** is for set the master and slave channel.

**Master:** channel that applies to mix. Channel 1 to channel 8 can be selected as the master channel.

**Slave:** channel 1 to channel 8 can be selected as the slave channel. The movement of the master channel side will include the movement of the slave channel side.

Click [2/2](#) at the top right corner to back to the first programmable mixing setting page from the second programmable mixing setting page.

## 2.6.9 Tilt mixing

Tilt mixing uses an outboard engine and applies bidirectional mixing from rudder to flap and from flap to rudder so that with a boat, rudder operation and tilt mixing operation can be performed 2 servos.

Tilt mixing can be performed by rudder operation, by steering wheel and flap channel.

**Mixing:** The button at the right of "Mixing" is OFF, and the background color of the select box is grey, indicating that the Tilt mixing function is turn off. The button at the right of "Mixing" is ON, and the background color of the select box is blue, indicating that the Tilt mixing function is turn on.

**CH1:** channel 1 to channel 8 can be selected to control the tilt steering.

**CH2:** channel 1 to channel 8 can be selected to control the tilt flap.

**CH1 rate/CH2 rate:** for the mixing amount rate. The initial value is 100%, -120% to 120% can be selected. Both CH1 and CH2 rate set positive or negative value, the tilt steering and tilt flap will keep move the same direction, while if the CH1 rate set the positive value and the CH2 rate set the negative value, the tilt steering and tilt flap will move the opposite direction.

**Flap:** flap rate check and adjustment. The initial value is 0%, -100% to 100% can be selected. The flap value set depends on the angle of the two flap (steering and flap). If you want to set the steering and flap separately, please set the value of Rudder to flap or Flap to rudder.

**Rudder to flap:** Rudder to Flap mixing amount can be adjusted individually. The initial value is 100%, -100% to 100% can be selected. -1% to -100% indicate the operate in same direction as steering. 0% to 100% indicate the opposite direction of steering.

**Flap to rudder:** Flap to Rudder mixing amount can be adjusted individually. The initial value is -100%, -100% to 100% can be selected. 0% to 100% indicate the operate in same direction as auxiliary channel. -1% to -100% indicate the opposite direction of auxiliary channel.

Steering end point function, curve function, speed function, or D/R function setup also effects flap channel operation. However, even if set, steering reverse function setup does not reverse the flap channel.

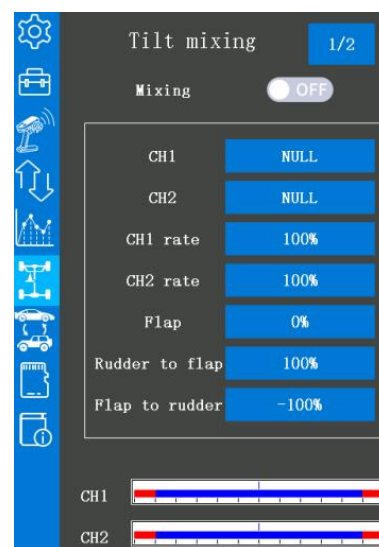

## Tilt Mixing 2/2

Click **1/2** at the top right corner to switch the first Tilt mixing setting page to the second Tilt mixing setting page.

**Flap:** DT1/DT2/DT3/DT4/DL1 can be selected to increase or decrease the Flap value. Press the button which you have selected to increase or decrease the value of flap, the mixing amount from rudder to flap and the mixing amount from flap to rudder will be adjusted.

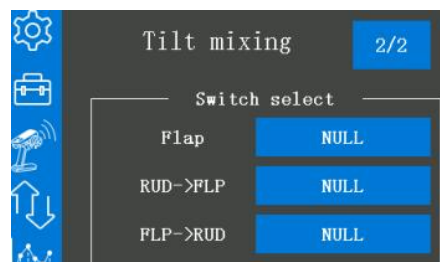

**RUD->FLP:** DT1/DT2/DT3/DT4/DL1 can be selected to adjust the mixing amount from rudder to flap.

**FLP->RUD:** DT1/DT2/DT3/DT4/DL1 can be selected to adjust the mixing amount from flap to rudder.

## 2.7 Model select

200 models' data can be saved in the transmitter RC8X. The name of every model can be renamed, and the factory settings of every model can be reset in this menu. Data can be copied and pasted between every two models. Click the model that needs to be set, and the following settings will appear on the screen.

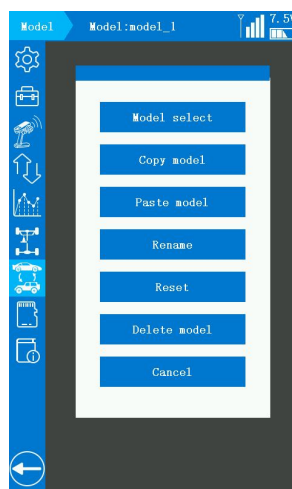
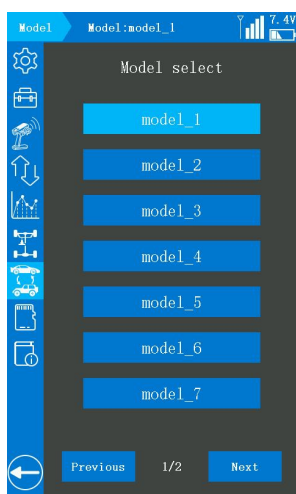

### 2.7.1 Model select

Model memory selection. You can choose from model 1 to model 200. Tap the mark "Previous" or "Next" at the bottom of screen to switch the page. When you click the button "Model select", a question "Are you sure to select the model: model\_1?" will pop out, click "Confirm" to select the model\_1 as the current model, the model's name can be renamed. If you do not want to select the model\_1, click "Cancel" and then choose the model's name you want. The model's name which you have selected will display on the top of the screen.

### 2.7.2 Copy model/Paste model

The contents of the model memory can be copied to another model memory. The copy model function and paste model function must be used as the same time to finished the model

memory copy. For example, if you want copy the model\_1 data to the model\_3, you need to click the button "model\_1" , click "Copy model" , click "Confirm" when the question "Are you sure to copy the model? model\_1" have pop out, and then click the button "model\_3" , click "Paste model" , click "Confirm" when the question "Copy model\_1 to model\_3?" have pop out.

**Attention:** when you click "Paste model" , a question "Copy data error. Please copy again!" means you have copy data, you have to copy data from another model and then paste to the model you need. Copy model and paste model will not succeed for one model.

### 2.7.3 Rename model

All the models' name can be renamed. For example, if you want to rename the model\_1, you need to click the button "model\_1" , click "Rename" , a keyboard will pop out, click "Delete" to delete the original name, tap "←" or "→" to move the cursor and select the character of the model name you want to set or change, click "Confirm" at the bottom of the screen to save the setting.

### 2.7.4 Reset model

All the models' data can be reset to the factory setting. For example, if you want to reset the memory of model\_1, you need to click the button "model\_1" , click "Reset" , click "Confirm" when the question "Are you sure to reset the model? model\_1" have pop out.

### 2.7.5 Delete model

Select the model to be deleted. Click Delete Model, and then confirm to delete the model.

## 2.8 SD Card Folder

Users can customize and change the content of the files. For example, they can add or delete firmware, modify the icon of the transmitter, and modify the prompt sound.

...: click the ... folder to back to the previous directory, click all the folders under this menu to enter the directory. Tap the mark "Previous" or "Next" at the bottom of screen to switch the page.



### 2.8.1 SD Card Folder Name Introduction

Folder Name	Function	Folder Name	Function
Debug Info	Debug information	ESC	Icon of ESC
Firmware	Firmware of RC8X	Desktop	Icon of desktop
FONT	Font of RC8X	Cache file	Cache file

SIF	font library, the RC8X will cannot power on if delete the SIF folder	Battery	Battery
Icon	All the Icons in RC8X	4WS	4 Wheel Steering
Signal	Icon of signal	Screenshot	Screenshot
setting	Icon of setting	Sounds	Sounds of RC8X
receiver	Icon of receiver	SYSTEM	System sounds of RC8X
file	Icon of files	USER	Sounds customized by users

## 2.8.2 SD Card Files Copy Methods

### 1) Copy the files with a card reader

① power off the RC8X, remove the SD card from RC8X, insert the SD card to a card reader, connect the card reader to the USB port of the computer.



② a "U Disk" will pop out when you connect the SD card to the computer, then all the files can be customized as you need.

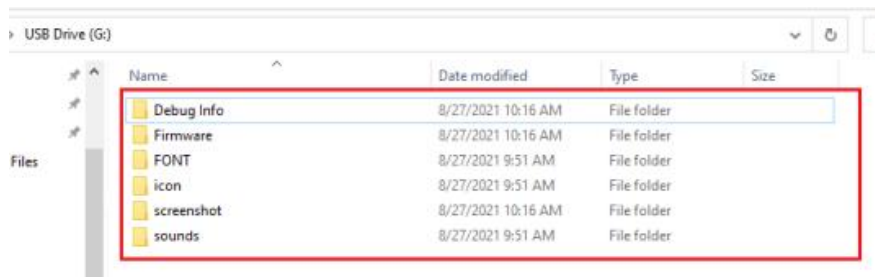

③ copy, delete, or customize the files you want, and then insert the SD card back to your transmitter RC8X.



## 2 ) Copy the files with a USB cable (copy a firmware as an example)

### Introduction about the nomenclatures that on the update setting menu

**SD Size:** the capacity of the SD card, if you replace a larger capacity SD card, the RC8X and computer connection will take longer to read the transmitter device information, about 2 minutes.

**SD Residue Size:** the remaining capacity of the SD card.

**DL1\_A: UP/DL1-B: DOWN:** make the yellow select box up or down by press the button DL1 to select the function you need.

**PS3:** press the button PS3 to back the previous setting menu.

**HOME:** at the update mode, by pressing the power button to confirm the setting/select.

**USB MODE:** press power button selects the "USB MODE" to make the SD card of RC8X connect to the computer

**Update the latest:** update the latest firmware that saved in the SD card of RC8X

**Upgrade the specified:** update the specified firmware that saved in the SD card of RC8X

**Power off:** exit the update setting menu and the RC8X will turn off at the same time.

### The setting steps as below:

- 1 ) keep the RC8X power off,
- 2 ) use a USB cable (type-c) connect the RC8X to the computer.



3 ) Push DT1 and DT2 TRIM buttons to the middle, and long press the power button at the same time to enter the data copy and upgrade mode. The following four options will appear on the screen, and "USB MODE" is selected by default.

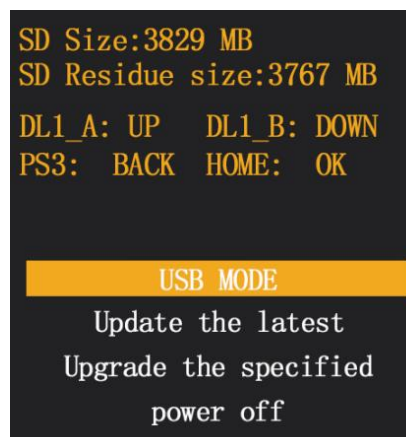

4 ) Short press the "power button" to enter the USB mode, and the computer will also remind



that a U disk is inserted. The computer usually displays two removable disks. RC8X-EXT refers to SD card, RC8X-INH refers to remote control. Copy the firmware to the RC8X-EXT disk.

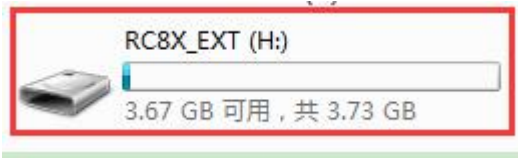

Note: The firmware downloaded from the official website is usually a compressed file. After downloading it to your computer, you need to unzip it first. After decompression, copy the three files (including Firmware, FONT, icon) in the folder to the RC8X-EXT disk.



Note: During the copying process, when it pops the reminder, please choose "copy and replace" and then click "YES" .

5 ) After the firmware copy is complete, press PS3 button to return to the previous menu. Then turn DL1 knob to turn the yellow background cursor to "power off" , and then short press "power button" to exit the upgrade mode.

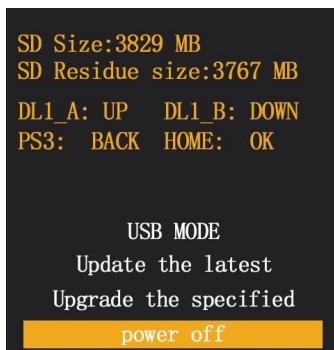

### 2.8.3 Note for SD card content modification

- 1) Do not modify, delete, or preview files directly in the RC8X. A type-c USB cable is needed to connect the RC8X and the computer to view and modify the files on the computer.
- 2) All filenames in the SD card only support English. If you change the filename to other languages, the filename will display garbled characters.
- 3) If the SD card is pulled out and then insert into the RC8X, the RC8X needs to be restarted to see the modified contents in the SD card.

## 2.9 Information

### 2.9.1 User name

The user name is default RADIO LINK, can be renamed, click the button "RADIO LINK", a keyboard will pop out, click "Delete" to delete the original name, tap "←" or "→" to move the cursor and select the character of the model name you want to set or change, click "Confirm" at the bottom of the screen to save the setting.

### 2.9.2 Language

The menu interface is available in multiple languages, including Simplified Chinese, Traditional Chinese, English, Japanese, Spanish, German and Russian. The menu language of RC8X is English by default,

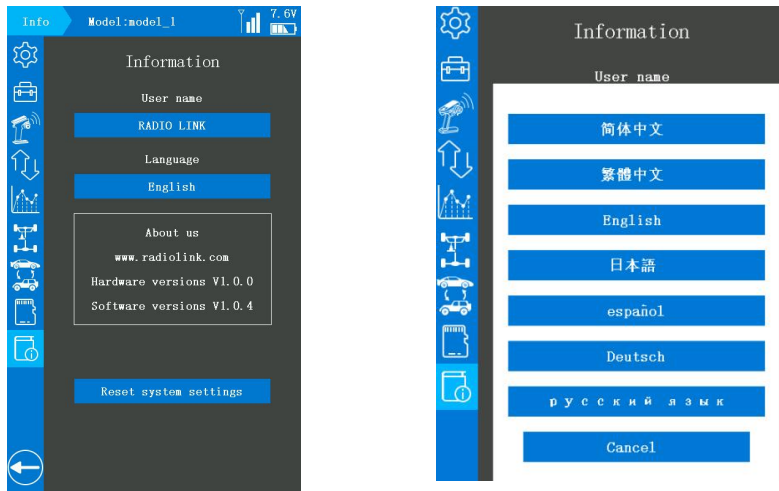

### 2.9.3 Reset system settings

The reset system settings function will make all the settings except the calibrate reset back to the factory settings.

Click button "Reset system settings", click "Confirm" when the question "Are you sure to reset system settings?" will pop out. Click Confirm to reset system settings.

Note: If you need to reset other setting parameters such as "Basic Menu", "Mixing Menu", etc., please go to "Model Selection" to reset the model data.

## 2.10 Modifying for Left-hand Use

The wheel section left and right installation direction can be reversed.

The wheel is default at the right of RC8X, users can reinstall it by a Phillips screwdriver.

The following operation takes the right-hand use modify to the left-hand use as an example:

### 2.10.1 Remove the Wheel

1) Use a Phillips screwdriver to remove the two mounting screws (HA3.0\*12mm screws) on the steering wheel adapter.

2) Gently pull off the steering wheel and do not pull the cable excessively. Since the steering wheel has been locked by the plastic sheet, please do not pull it out directly.

3) Remove the three cables from the PCB board of RC8X, press the socket on the RC8X

4) Pull out the plastic plate under the wheel.



## 2.10.2 Remove the Wheel Installation Port Cover

- 1) Use the Phillips screwdriver to remove the two mounting screws (HA3.0\*12mm screws) on the left wheel installation port cover.
- 2) Gently pull off the left wheel installation port cover.
- 3) Gently pull out the USB port motherboard.
- 4) Remove the cable from the RC8X PCB board.





### 2.10.3 Install Wheel

1) Insert the 14pin plug, 3pin plug and 4pin plug on the steering wheel into the corresponding socket in the middle of the PCB motherboard on the left side of the RC8X.

2) Insert the plastic steering mounting plate. When inserting part of it, gently insert the extra part of the 3 connector wires into the interlayer of the RC8X PCB board.

*Note: do not block the installation position of the two screws when jamming the cables. Otherwise installing the wheel will crush the cable.*

3) Align the steering wheel installation screw mounting position and the screw mounting position of RC8X.

4) Tighten the two screws.



### 2.10.4 Install the Wheel Installation Port Cover

1) Insert the 11pin plug on the plate into the corresponding port of the PCB motherboard on the right side of the RC8X.

2) Gently insert the extra part of the wire into the interlayer of the RC8X PCB board.

3) Insert the black plastic steering mounting plate into the corresponding wheel installation port.

4) Cover the black plastic USB port plate, tighten the two screws.





The picture is as follows after modifying the wheel from the right to the right:



## 2.11 Wheel or Trigger Mechanical Adjustment

The wheel or trigger of RC8X can be adjusted mechanically according to your needs.

### 2.11.1 Trigger brake lever adjustment

Make this adjustment when you want to decrease the stroke of the brake side of the throttle trigger for operation feel.

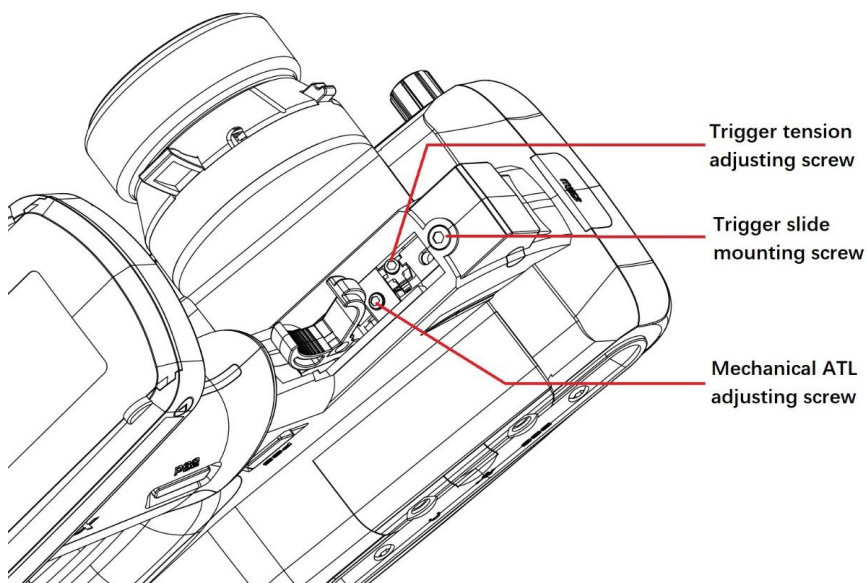



Adjustment steps: Using a 1.5mm hex wrench, loosen the trigger tension screw (1.5mm) by turning it slightly counterclockwise.

**Note:** Adjust the stroke while observing the screw. Once the mechanical stroke of the throttle is changed, please re-calibrate the throttle trigger. The calibration method refers to [2.1.10 "Calibration"](#). Due to this change, it is also necessary to adjust the throttle rudder in most cases. The stroke of the machine can be set through "EPA".

### 2.11.2 Trigger tension screw adjustment

Adjust the trigger tension screw when you want to change the tension of trigger spring.

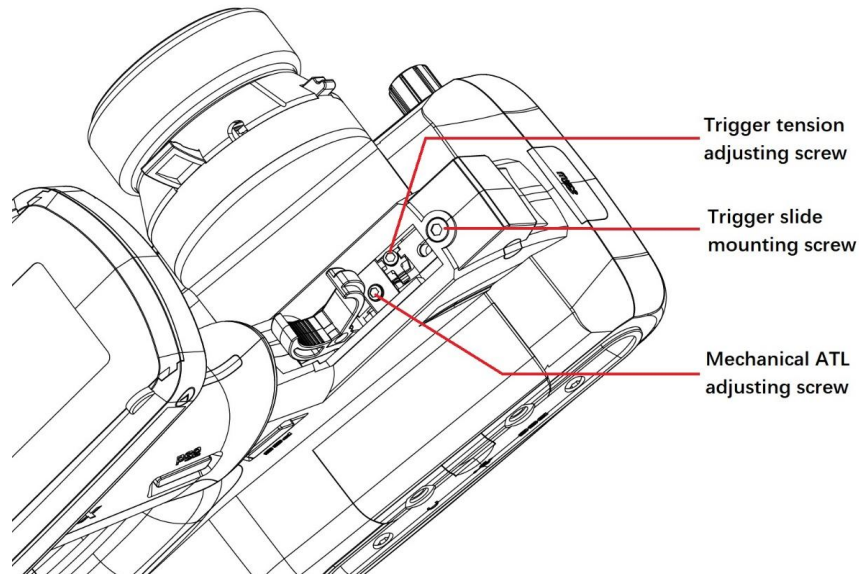

Adjustment steps: Using a 1.5mm hex wrench, loosen the trigger tension screw (1.5mm) by turning it slightly counterclockwise. If the trigger tension screw is turned too much, the screw may fall out. When the adjusting screw is turned clockwise, the spring tension increases.

### 2.11.3 Trigger slide adjustment

The throttle trigger position can be moved forward and backward by loosening or tightening the screw.

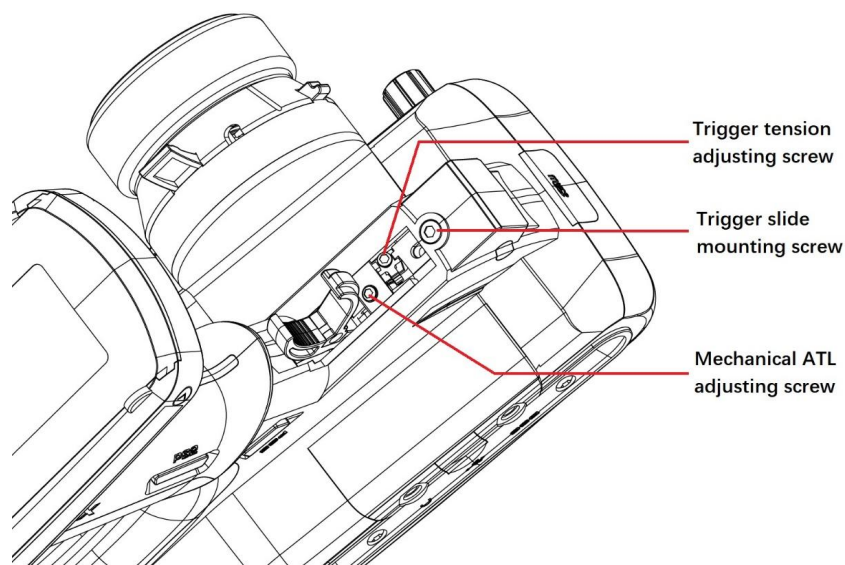

**Adjustment steps:** Using a 2.0mm hex wrench, loosen the trigger slide mounting screw (2.0mm) by turning it slightly counterclockwise. If the trigger slide screw is turned too much, the screw may fall out.

## 2.11.4 Wheel tension screw adjustment

Adjust the wheel tension screw when you want to change the tension of wheel spring.



**Adjustment steps:** Using a 1.5mm hex wrench, loosen the trigger tension screw (1.5mm) by turning it slightly counterclockwise. If the trigger tension screw is turned too much, the screw may fall out.

## 2.12 Firmware Update

RC8X will keep to update the firmware to add new functions. Please pay attention to our website [www.radiolink.com](http://www.radiolink.com) to get the latest firmware.

Before update, the latest firmware must copy to the micro SD card of your RC8X.

### 2.12.1 Methods for Firmware Copy

Please refer to: [2.8.2 SD Card Files Copy Methods](#)

### 2.12.2 Methods for Firmware Upgrade

There are two ways for RC8X to update the software in total.

#### 1) "Update the latest" Mode

If there are several firmware saved in the microSD card, RC8X will recognize the latest firmware automatically and then update it at this update mode.

① Enter the update mode setting menu

>power on the RC8X, but do not turn it on.

>Push DT1 and DT2 TRIM buttons to the middle, and long press the power button at the same time to enter the data copy and upgrade mode. The computer will pop out that a USB drive is inserted.



② select update mode

- > The following four options will appear on the screen, and "USB MODE" is selected by default.
- > Turn DL1 knob to turn the yellow background cursor to "Update the latest"

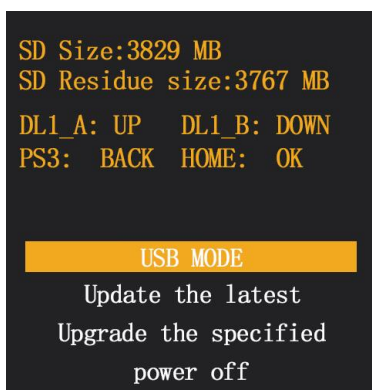

③ upgrade the latest firmware

- > short press the power button into the "Update the latest" mode, short press the power button again to upgrade.
- > "being updated" pop out at the bottom of the screen means the firmware is updating.

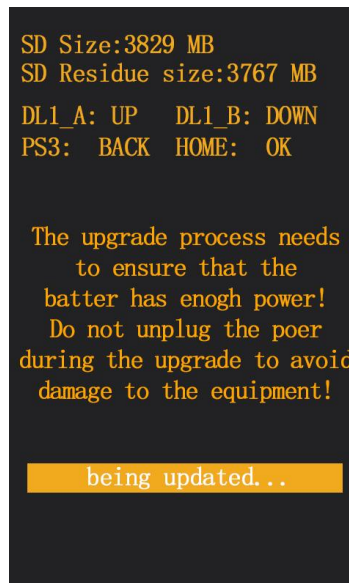

④ “update successfully” pop out at the bottom of the screen means the firmware upgrade is successful.

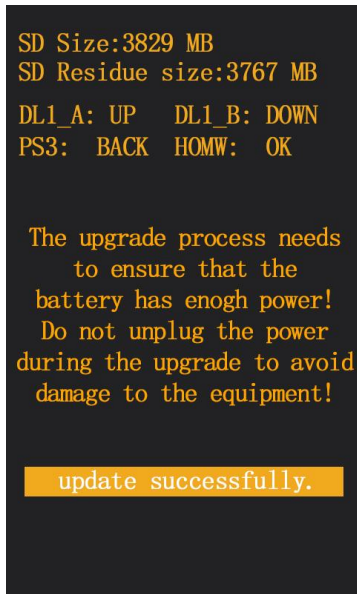

⑤ exit the update mode

- > Press PS3 button to return to the previous menu.
- > Turn DL1 knob to turn the yellow background cursor to “power off” .
- > Short press the power button to exit the upgrade mode.

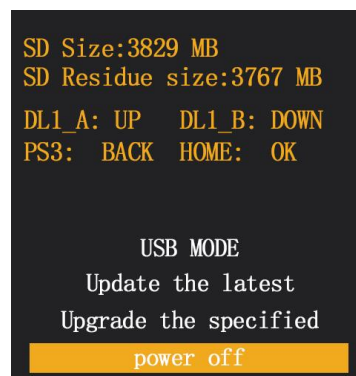

**Attention:** if “firmware reads fail!” pop out at the bottom of the screen means the transmitter RC8X have not find out the firmware from the microSD card, please copy the latest firmware to the microSD card first, and then reupdate follow the steps above.

## 2) “Upgrade the specified” Mode

If you have copied the upgrade firmware to the microSD card, but you have modified the firmware name, then the “Upgrade the specified” update mode is be suggested.

① Enter the update mode setting menu

>power on the RC8X, but do not turn it on.

>Push DT1 and DT2 TRIM buttons to the middle, and long press the power button at the same time to enter the upgrade mode. The computer will pop out that a USB drive is inserted.



② select update mode

- > The following four options will appear on the screen, and "USB MODE" is selected by default.
- > Turn DL1 knob to turn the yellow background cursor to "Update the specified"

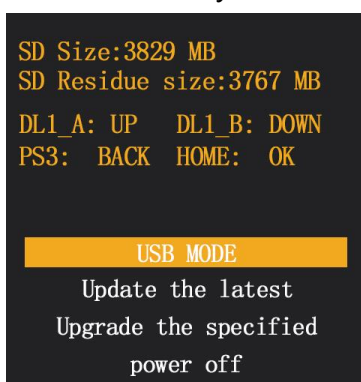

③ upgrade the specified firmware

- > short press the power button into the "Update the specified" mode, short press the power button again to upgrade.
- > "being updated" pop out at the bottom of the screen means the firmware is updating.

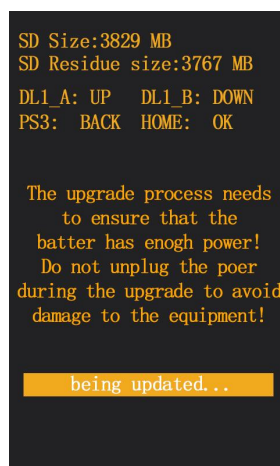

- ④ "update successfully" pop out at the bottom of the screen means the firmware upgrade is successful.



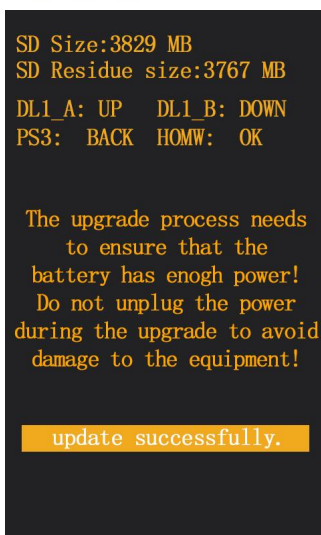

⑤ exit the update mode

- > Press PS3 button to return to the previous menu.
- > Turn DL1 knob to turn the yellow background cursor to "power off" .
- > Short press the power button to exit the upgrade mode.

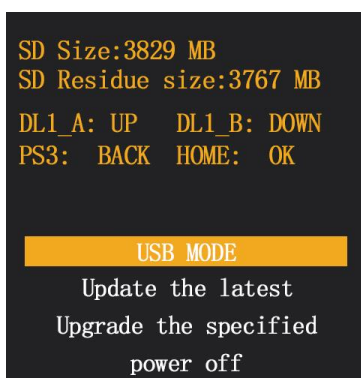

## 2.13 Customized Voice Production

Not only the voice package that comes with RC8X, but also the customized voice is available for user to set the Audio source. Users can make custom prompt voice production through text-to-speech software, and then copy the voice file to the transmitter, where they can choose their own voice. It is specially designed for users in non-English language countries.

1. After recording the voice file, modify the format of the voice file to ensure that the format of the voice file meets the following 4 conditions:

- a. WAV format
- b. Sampling rate 16KHZ or 32KHZ
- c. Mono
- d. Bit depth 16 bits

The following steps show how to convert the format of an audio file to make it meet the above 4 conditions. Take Adobe Audition voice software as an example.

(1) Import the voice file whose format needs to be modified into Adobe Audition software, and then click File - Save As.

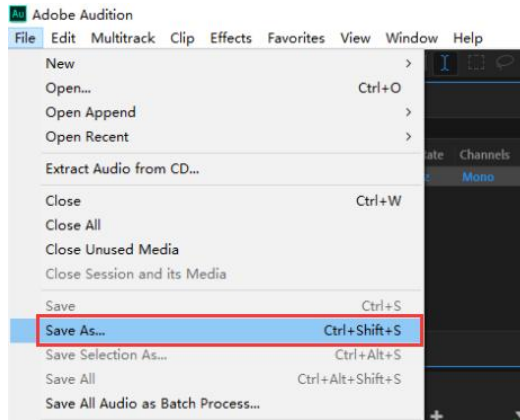

(2) Modify the voice file format to ensure that the format conforms to WAV format, Sample rate 16KHZ or 32KHZ, monophonic, and 16 bits depth. After selecting the save location, click OK, and a qualified voice file will be generated.

Note: Don't tick "Include markers and other metadata".

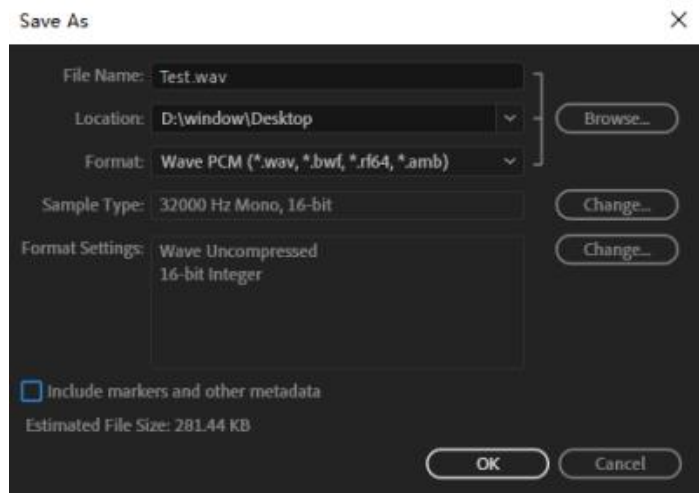
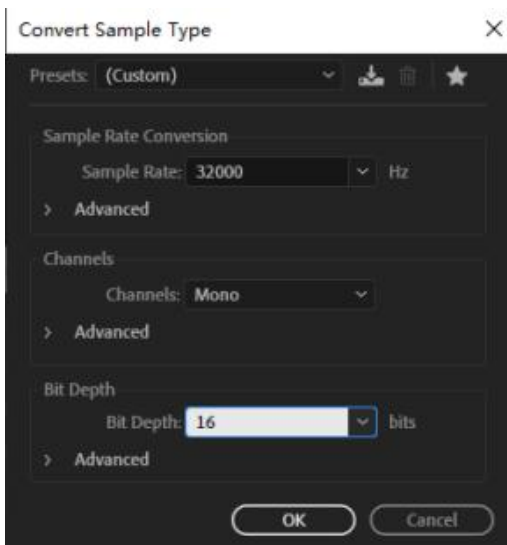

2. Copy the voice file to RC8X.

Please refer to [2.8.2 SD Card Files Copy Methods](#) to copy the modified audio to RC8X\_EXT(H) -sounds-USER. (The file name is "Test" )

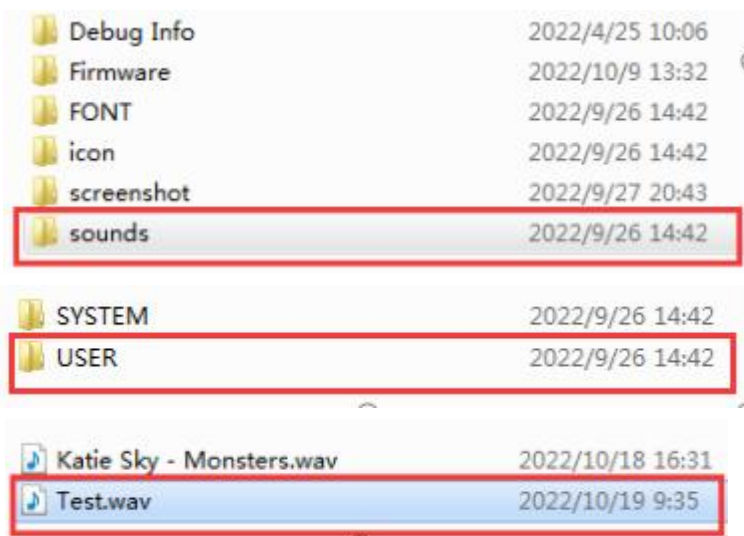

3. Select your own voice prompts on RC8X. When setting a Trim/Dial tone and Switch sound, select Customized voice, and then the corresponding audio file. (The file name is "Test" )

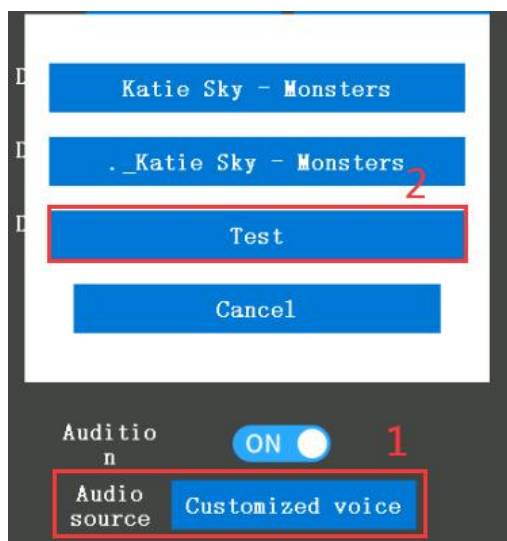

## Thanks

Thank you so much for choosing RadioLink 2.4 GHz 8 channels transmitter – RC8X.

To fully enjoy the benefits of this product and ensure safety, please read the manual carefully and set up the device as instructed steps. If any problems found during the operation process, either way listed below can be used as online tech support.

1. Send mails to [after\\_service@radiolink.com.cn](mailto:after_service@radiolink.com.cn) and we will answer your question at the earliest.
2. Send private message to us on our Facebook page or leave comments on our YouTube page.
3. If the product is purchased from the local distributor, you can also ask them for support and repair as prefer.

A 32G SD card will be packed with RC8X, it can be used for transmitter upgrade or save the font, icon, screenshot, sound, and other customized files you have designed for your RC8X.

All manuals and firmware are available on RadioLink official website [www.radiolink.com](http://www.radiolink.com) and more tutorials will be uploaded. Follow our Facebook and YouTube homepage to stay tuned with our latest news.